

**WYLER**

# MANUAL

# SENSORS ZEROTRONIC

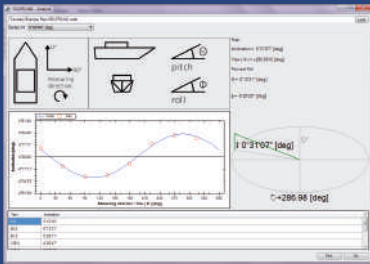

**WYLER AG**  
INCLINATION MEASURING SYSTEMS  
NEIGUNGSMESSSYSTEME

Im Holderli 13, CH -8405 WINTERTHUR (Switzerland)  
Tel. +41 (0) 52 233 66 66 Fax +41 (0) 52 233 20 53  
E-Mail: wyler@wylerag.com Web: www.wylerag.com





## **CONTENT**

<b>Subject</b>	<b>Page</b>
<b>1. THE ZEROTRONIC SENSOR, THE DESIGN AND THE DIGITAL MEASURING PRINCIPLE</b>	<b>7</b>
1.1. MEASURING PRINCIPLE	7
1.2. ZEROTRONIC-SENSORS / TWO SENSOR- TYPES TYPE 3 AND TYPE C	7
1.3. ZEROTRONIC 3	9
1.4. ZEROTRONIC C	9
1.5. DYNAMIC CHARACTERISTICS OF ZEROTRONIC-SENSORS	9
1.6. CALIBRATION OF DIGITAL SYSTEMS	10
1.7. SHOCK / VIBRATIONS	10
1.8. ZERO POINT AND LONG-TERM STABILITY	10
1.9. STANDARD-CONFIGURATIONS WITH ZEROTRONIC-SENSORS	11
<b>2. SHORT DESCRIPTION OF THE MEASUREMENT ANALYSIS</b>	<b>13</b>
2.1. WYBUS MODULE	13
2.1.1. WYBUS-DEVELOPMENT-KIT	13
2.1.2. WYLERCHART	13
2.2. MEASUREMENT-ANALYSIS WITH A LEVELMETER 2000	15
2.3. MEASUREMENT-ANALYSIS WITH A BLUEMETER SIGMA	15
2.4. WYLERDYNAM / THE MEASURING-SOFTWARE FOR ZEROTRONIC-SENSORS	16
<b>3. CHANGING ADDRESSES OF THE SENSORS AND MEASURING INSTRUMENTS CONNECTED</b>	<b>17</b>
3.1. PRINCIPAL DESCRIPTION OF THE LEVELMETER 2000	17
3.2. PRINCIPAL DESCRIPTION OF THE BLUEMETER SIGMA	19
<b>4. INTERFACES ZEROTRONIC-SENSORS TO PC/LAPTOP</b>	<b>21</b>
<b>ANNEX</b>	<b>22</b>
<b>A TYPICAL APPLICATIONS WITH ZEROTRONIC SENSORS</b>	<b>22</b>
<b>B MOST IMPORTANT ZEROTRONIC SPECIFICATIONS OVERVIEW</b>	<b>23</b>
B1 ZEROTRONIC 3	23
B2 ZEROTRONIC C	24
B3 DETAILED SPECIFICATIONS OF ZEROTRONIC-SENSORS	25
B3.1 GENERAL	25
B3.2 PIN-ASSIGNMENT	25
B3.3 SENSOR DIMENSIONS	26
B3.4 DC CHARACTERISTICS ZEROTRONIC-SENSOR	26
B3.5 RS485-INTERFACE	26
B4 RS485 MESSAGES HOST <<< -- >>> ZEROTRONIC	27
<b>C DETAILED SPECIFICATIONS OF THE TRANSCEIVER T/C</b>	<b>30</b>
C1 GENERAL	30
C2 PIN-ASSIGNMENT TRANSCEIVER/CONVERTER	31
C3 ABSOLUTE MAXIMUM RATINGS	32
C4 DC CHARACTERISTICS	32
C5 RS232 INTERFACE	32
C6 CONFIGURATION WITH WYLER NETWORK ... RS485	33
C7 CONFIGURATION WITH WYLER NETWORK ... RS232	33
C8 SAMPLE ANGLE READOUT FLOWCHART (RS232)	33
C9 CONFIGURATION WITH WYLER NETWORK AND WITH "WYLERDYNAM"	34

<b>D</b>	<b>INTRODUCTION MULTiTC</b>	<b>35</b>
D1	DESCRIPTION OF THE INTERFACE MULTiTC	35
D2	GENERAL	35
D3	POSSIBLE CONFIGURATIONS (EXAMPLE WITH ZEROTRONIC-SENSORS)	36
D4	PIN-ASSIGNMENT	36
D5	ABSOLUT MAXIMUM RATINGS	37
D6	DC CHARACTERISTICS	37
D7	RS232-INTERFACE	37
<b>E</b>	<b>SPECIFICATIONS BLUETC</b>	<b>37</b>
E1	BLUETC WITH WIRELESS MODULE (DETAILS)	37
E1.1	GENERAL	37
E1.2	TYPICAL CONFIGURATIONS WITH BLUETC	38
E2	INITIAL STARTUP OF THE BLUETC	37
E2.1	COMBINE A GROUP OF INSTRUMENTS TO A MEASUREMENT GROUP USING THE FUNCTION „JOIN“ IN RADIO TRANSMISSION MODE	39
E2.2	UNHINGE AN INSTRUMENT IN THE RADIO MODE FROM A GROUP, USING THE FUNCTION „LEAVE“	40
E3	RENEWED CONNECTION OF A MEASURING GROUP	40
E4	TYPICAL CONFIGURATIONS WITH BLUETC	41
E5	OVERVIEW OF THE BLUETC	41
E5.1	FUNCTIONAL MENU WITH BLUETC / STRUCTURE	42
E5.2	OPERATING THE BLUETC / SHORT DESCRIPTION OF THE VARIOUS KEYS	43
E5.3	PIN-ASSIGNMENT OF THE BLUETC	44
E5.4	TECHNICAL DATA OF THE INTERFACE BLUETC	44
E5.5	DIMENSIONS OF BLUETC	45
<b>F</b>	<b>SENSOR STORAGE</b>	<b>46</b>
<b>G</b>	<b>REPAIR OF MEASURING INSTRUMENTS</b>	<b>46</b>

### Änderungen / Modifications:

Datum / Date	Geändert durch Modified by	Beschreibung der Änderung Description of modifications
10.1.2003	HEH/MO	Index included
2.4.2003	HEH	New:Express Repair Service
15.9.2003	HEH/MO	Warm up phase/ Storage
15.4.2004	HEH	Various modifications
19.1.2007	HEH	Complete revision, BlueSYSTEM new
11.9.2009	HEH	ZEROTRONIC sensor specifications modified
2.1.2010	HEH	Complete redesign
18.5.2015	HEH	New: ZEROTRONIC-Sensoren mit Multi TC
22.1.2016	MG	Sample angle readout flowchart corrected
13.3.2018	MG	BlueTC new configuration and new design, software wylerCHART

## INDEX

### A

ADDRESSES OF THE SENSORS	3	17
ANNEX		22
APPLICATIONS FOR THE ZEROTRONIC SENSORS	1.4	9
APPLICATIONS WITH ZEROTRONIC SENSORS	A	22

### B

BLUEMETER SIGMA	2.3	15
BLUEMETER SIGMA	3.2	19
BLUETC	E	37
BLUETC / DIMENSIONS OF BLUETC	E5.5	45
BLUETC / OPERATING THE BLUETC	E5.2	43

### C

CALIBRATION OF DIGITAL SYSTEMS	1.6	10
CHANGING ADDRESSES OF THE SENSORS	3	17
COMMAND / RESPONSE DATA FRAME STRUCTURE	B4	28

### D

DC CHARACTERISTICS ZEROTRONIC-SENSOR	B3.4	26
DESCRIPTION OF THE MEASUREMENT ANALYSIS	2	13
DIFFERENCE IN CHARACTERISTICS OF THE 2 SENSORS	1.2	7
DIGITAL SENSOR-FAMILY ZEROTRONIC	1.1	7
DIMENSIONS	1.8	11
DYNAM / THE MEASURING-SOFTWARE FOR ZEROTRONIC-SENSORS	2.4	16
DYNAMIC CHARACTERISTICS OF ZEROTRONIC-SENSORS	1.5	9

### E

EXPRESS REPAIR SERVICE, ERS	F	46
-----------------------------	---	----

### H

HIGH TEMPERATURE RANGE	1.6	10
------------------------	-----	----

### I / J

INTERFACES ZEROTRONIC-SENSORS TO PC/LAPTOP	4	21
JOIN / PROCEDURE FUNCTION „JOIN“	E2.1	39
KEY WORD	CHAPTER	PAGE

### L

LABEXCEL (LABVIEW-APPLICATION)	2.1.2	13
LEAVE / PROCEDURE „LEAVE“	E2.2.1	40
LEVELMETER 2000	2.2	15
LONG-TERM STABILITY	1.8	10

### M

MULTITC	D	35
---------	---	----

### P

PIN-ASSIGNMENT OF THE BLUETC	E5.3	44
PIN-ASSIGNMENT	B3.2	25
PIN-ASSIGNMENT TRANSCEIVER/CONVERTER	C2	31

### R

RENEWED CONNECTION OF A MEASURING GROUP	E3	40
RS485 MESSAGES HOST <<< -- >>> ZEROTRONIC	B4	27
RS485-INTERFACE	B3.5	26

### S

SHOCK / VIBRATIONS	1.7	10
SPECIFICATIONS ZEROTRONIC	B	23
SPECIFICATIONS ZEROTRONIC 3	B1	23
SPECIFICATIONS ZEROTRONIC C	B2	24
STANDARD.CONFIGURATIONS WITH ZEROTRONIC-SENSORS	1.9	11

STARTUP OF THE BLUETC	E2	38
STORAGE / SENSOR STORAGE	F	46
<b>T</b>		
TRANSCEIVER T/C	C	30
TWO SENSOR- TYPES - TYPE 3 AND TYPE C	1.2	7
TYPICAL CONFIGURATIONS WITH BLUETC	E4	41
<b>U / V</b>		
VIBRATIONS / SHOCK	1.7	10
<b>W</b>		
WyBUS MODULE	2.1	13
WyBUS-DEVELOPMENT-KIT	2.1.1	13
<b>Z</b>		
ZERO POINT AND LONG-TERM STABILITY	1.8	10
ZEROTRONIC SENSOR, THE DESIGN AND THE DIGITAL MEASURING PRINCIPLE	1	7
ZEROTRONIC 3	1.2	7
ZEROTRONIC C	1.2	7

## 1. THE ZEROTRONIC SENSOR, THE DESIGN AND THE DIGITAL MEASURING PRINCIPLE

### 1.1 DIGITAL SENSOR-FAMILY ZEROTRONIC

The sensors of the ZEROTRONIC family have a digital inclination sensor and a digital data transmission. Working digitally, they provide the option to compensate for temperature changes and allow data communication over long distances without any loss of data.

The combination of all these features ensures that these sensors fulfil highest requirements regarding precision, resolution, sensitivity and temperature stability.

ZEROTRONIC-sensors have established themselves in the market as the benchmark when it comes to high precision inclination measurement in demanding applications.

The ZEROTRONIC-sensor-family features particularly the following characteristics:

- High resolution and high precision
- Excellent temperature stability
- Measuring ranges of  $\pm 0.5$  to  $\pm 60$  degrees
- Synchronized registration of measuring values for several sensors
- High immunity to shock
- High immunity to electromagnetic fields

### 1.2 ZEROTRONIC-SENSORS / TWO SENSOR- TYPES - TYPE 3 AND TYPE C

Within the ZEROTRONIC family there are 2 sensor-types available which have slightly different physical characteristics:

#### ZEROTRONIC 3 ZEROTRONIC C

Common characteristics of the 2 sensors:

- The outer dimensions and the electrical characteristics of the two sensors are identical.
- The measuring element in both sensors is based on a pendulum swinging between two electrodes. Depending on the inclined position of the system, the pendulum will change its position in relation to the electrodes and by that, the capacitance between the pendulum and the electrodes will change. The change of these capacitances is measured digitally.
- The sensor cell is completely encapsulated and therewith protected against changes in humidity.
- Both sensors are calibrated over the complete measuring range with reference points stored in the EEPROM of the sensor.
- Both sensors are equipped with a temperature sensor and are temperature calibrated allowing an excellent compensation for temperature changes.

Difference in characteristics of the 2 Sensors:

- The pendulum of the ZEROTRONIC 3 is larger which provides a significantly better signal to noise ratio for smaller inclinations. The ZEROTRONIC 3 is therefore better suited for high precision applications where small inclinations are measured only.
- The mass of the pendulum of the ZEROTRONIC C is smaller than the one of sensor Type 3. This provides a higher stability, if the sensor is permanently inclined.



Only ZEROTRONIC 3 provides the option of analog output.

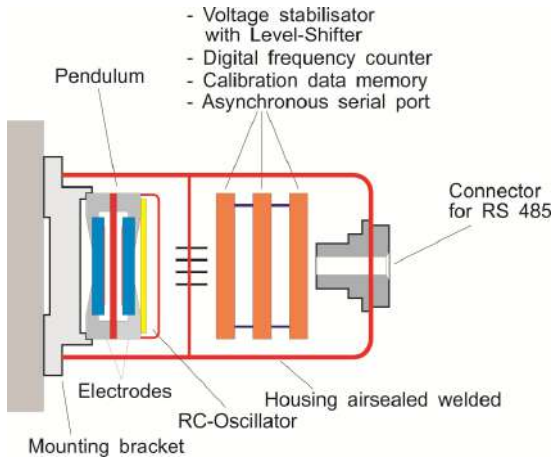

### MEASURING RANGES

The ZEROTRONIC-Sensors is available in six basic versions in respect of measuring ranges:

- **ZEROTRONIC 3;**  
Measuring Range  $\pm 0.5$  Deg.
- **ZEROTRONIC 3;**  
Measuring Range  $\pm 1$  Deg.
- **ZEROTRONIC 3;**  
Measuring Range  $\pm 10$  Deg.
- **ZEROTRONIC 3;**  
Measuring Range  $\pm 30$  Deg.
- **ZEROTRONIC C;**  
Measuring Range  $\pm 10$  Deg.
- **ZEROTRONIC C;**  
Measuring Range  $\pm 30$  Deg.
- **ZEROTRONIC C;**  
Measuring Range  $\pm 45$  Deg.
- **ZEROTRONIC C;**  
Measuring Range  $\pm 60$  Deg.

The high stability and accuracy of the ZEROTRONIC-sensors is among others based on the fact that only one single oscillator is applied which is switched by a SELECTOR alternatingly to the two electrodes. This approach ensures that temperature influences can be minimised and the long term stability is optimised.

The frequency-differences between the two oscillating circuits are measured digitally and out of these values the inclination is calculated.

Due to this concept the signal to noise can be optimised and the inclination can be determined very accurately.

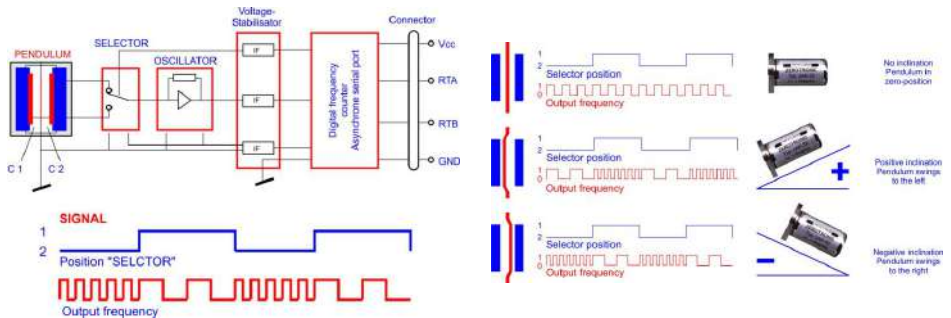



The following list of characteristics should allow a proper differentiation and proper application of the 2 sensors:

### 1.3 ZEROTRONIC 3

- High resolution, high precision for inclinations up to 30°
- Excellent signal to noise ratio
- Excellent repeatability
- Excellent linearity
- Excellent temperature stability

#### Some typical applications for the ZEROTRONIC 3

Applications, where high precision and high resolution is first priority and where only small inclinations are measured:

- Adjustment of machines (e.g. pitch and roll)
- Precise adjustment of absolute zero
- Precise measurement of small inclinations in heavy duty environment; e.g. exposure to outside temperature

### 1.4 ZEROTRONIC C

- Excellent precision for inclinations between 10° and 60°
- Excellent repeatability
- Excellent long term stability in inclined position
- Excellent linearity
- Excellent temperature stability

#### Some typical applications for the ZEROTRONIC C

- Larger inclinations
- Sensor remains in inclined position over a longer period of time

### 1.5 DYNAMIC CHARACTERISTICS OF ZEROTRONIC-SENSORS

Inclination sensors are highly sensitive acceleration sensors which are measuring the deviation from earth gravity. Each non-constant movement produces accelerations which will impact the inclination sensor: the stronger these external acceleration-components, the lower the resulting accuracy of the inclination measurement will be.

Inclination measurements on moving objects are basically possible if these boundary conditions kept in mind.

Examples of applications which are functioning well:

- Roll measurement on machines which are moving evenly along one axis.
- Inclination measurement on a boat which is in a protected harbour-area.
- Inclination measurement on a container which is lifted.

By adapting measuring speed and integration time the accuracy can be optimised.

Examples of applications which are not functioning:

- Inclination measurement on a train during a turn (the Coriolis acceleration is too big)
- Inclination measurement on a boat on open sea (the accelerations due to the motion of the sea are too large)

## 1.6 CALIBRATION OF DIGITAL SYSTEMS

Each single sensor is individually calibrated over the complete measuring range as well as over the complete temperature range the sensor is going to be used. These calibration values are stored as reference points in the EPROM of the sensor.

### Two temperature calibrations are available:

The **standard temperature calibration** is well suited for sensors which are used in a typical laboratory or a machine shop environment: Temperatures around 20° C and slow temperature changes.

The **HTR (High temperature range) calibration** is suited for those sensors which are exposed to outdoor conditions. These sensors are calibrated at various temperatures, which ensures, that they are well functioning for the whole temperature range the sensor can be used, which is from - 40°to + 85°C. Thanks to the extended and more elaborate temperature-calibration the HTR sensors show a substantially lower temperature coefficient which is 1/5 of the value of a standard temperature calibration (see technical specification)

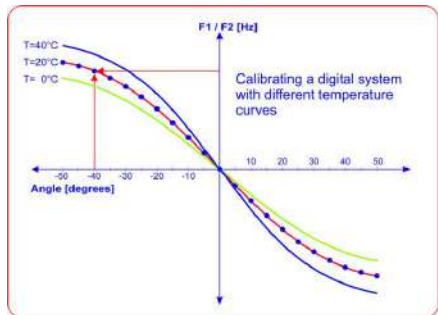

### Remark:

Even with an HTR calibration it has to be ensured that the sensors are protected against direct sunlight and that temperature changes are impacting the sensors evenly from all sides.

## 1.7 SHOCK / VIBRATIONS

Due to the compact design (minimized dimensions) and the design selected for the ZEROTRONIC sensors, this measuring instrument is insensitive against shocks and vibrations to a great extent. The pendulum chamber is designed in a way, avoiding damage or permanent deformation of the pendulum unit after shocks or vibrations even when in a position with large angular displacement

- Limitation of horizontal displacement: +/- 0,3mm
- Limitation of radial displacement: +/- 0,2mm

## 1.8 ZERO POINT AND LONG-TERM STABILITY

Based on the factors listed here after an excellent stability of the Zero point and the long-term drift can be assured:

- Symmetric construction
- The pendulum contains near to no internal tension at the Zero point
- The two condensers have the same capacity in Zero position
- The transformation into frequencies is done by a single RC-Oscillator
- All resistance's are connected symmetrically
- All parts relevant for the metrology are made of the same material
- Metallic joining by laser welding technology, thus giving minimum and only localized heating to the sensor and the sensor housing during production

Therefore only possible symmetry deviations, due to differences in temperature, ageing of the single elements and temperature gradients can influence the Zero point stability. The temperature stability can be improved considerably by calibrating of the sensor at different temperatures. The actual temperature of the sensor is measured near to the measuring cell. The system interpolates the calibration values between the calibration curves nearest to the actual temperature and transmits the calculated value to the evaluation unit.

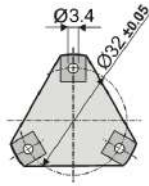
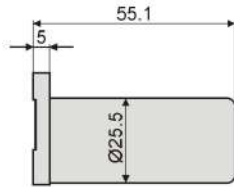

### 1.9 STANDARD CONFIGURATIONS WITH ZEROTRONIC-SENSORS

The customer buys the ZEROTRONIC-sensor and is responsible for the signal treatment by himself. This means the **customer is using the own developed software**. In order to be able to do so the respective sensor specifications are described in this chapter.



ZEROTRONIC-sensors connected directly to a **LEVELMETER 2000**



*Connection through cable*

ZEROTRONIC-sensors connected directly to a **BlueMETER SIGMA**

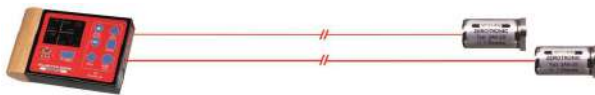

*Connection through cable*

ZEROTRONIC-sensors connected to a PC/Laptop on RS485-Bus through one or more MultiTC. Analyze of measuring results utilizing software wylerDYNAM. External Power supply via Transceiver/Converter.

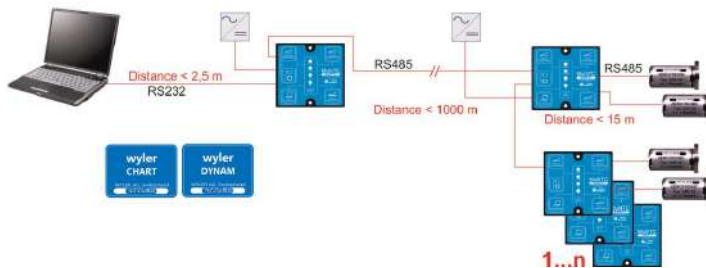

*Connection through cable*

*Connection through wireless data transmission*

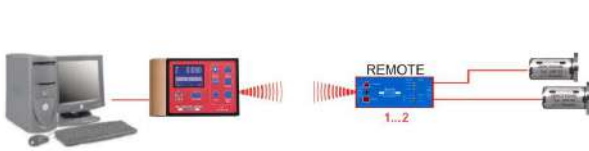

ZEROTRONIC-sensors connected to a PC/Laptop through a BlueMETER SIGMA and up to two BlueTC. The BlueTC is used as interface for data transmission through **wireless connection**.

To each BlueTC up to 2 sensors may be connected. In total the system can handle 4 addresses.

Analyze of measuring results utilizing software wylerCHART.

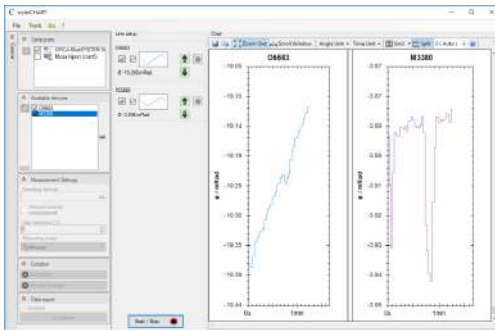

## 2. SHORT DESCRIPTION OF THE MEASUREMENT ANALYSIS

### **Important:**

Before starting any precision measurement the ZEROTRONIC sensor should be powered for at least **15 minutes**. This is to avoid a possible start-up drift of the electronic components (warm up period).

### 2.1 WYBUS MODULE

#### 2.1.1 WYBUS-DEVELOPMENT-KIT

For users who would like to define and program their own measuring software for WYLER inclination sensors, WYLER AG provides a WyBus-development-kit with self-explaining samples.

An essential part of these examples is a WyBus core (a \*.dll-file) allowing a standardised and simplified communication with all WYLER sensors. This file provides the following functionality

#### 1. COM port management

- Listing of the COM ports
- Selection of the COM ports to be used

#### 2. Instruments and sensor administration

- Listing of instruments and sensors
- Selection of the sensors to be measured by their ID

#### 3. Reading of measuring values

- Adjustment of measuring parameters
- Selection of measuring speed / sampling rate
- Measuring values to be read (displayed angle, temperature)
- Reading / memorizing of measuring values in the background
- Reading in / transfer of values measured in the background at any time

Standard program examples are currently available for the following programming environments:

- C#
- samples for other platforms can be provided upon request

WYLER AG provides this WyBus Development kit **free of charge** to WYLER customers.

#### 2.1.2 WYLERCHART

The software LabEXCEL is a software package which is easy to operate for the displaying of the measuring values of WYLER inclination measuring instruments and sensors. The core is the WYLER WyBus-module. This software ensures the communication between the inclination measuring instruments and sensors and the user interface.

The measuring results can be transferred into an EXCEL file for further treatment.

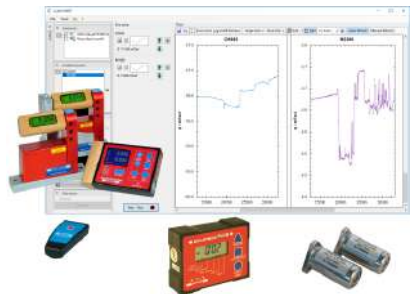

Requirements for the installation of the software „wylerCHART“

- Windows 7, Windows 8 or Windows 10
- Min. 100 MB free space on hard disc

Up to **10 WYLER-inclination measuring instruments or sensors** can simultaneously be read into the software „wylerCHART“. In addition there is the possibility of displaying the difference of the measuring values between any pair of 2 different inclination measuring instruments or sensors.

## 2.2 MEASUREMENT-ANALYSIS WITH A LEVELMETER 2000

The **LEVELMETER 2000** has been developed as an intelligent Hand Terminal together with the digital sensors of the ZEROTRONIC-family and as a display unit for the electronic inclinometers MINILEVEL NT and LEVELTRONIC NT. Apart from the high precision, the measuring instruments ZEROTRONIC-sensors, MINILEVEL NT and LEVELTRONIC NT feature in particular that the measuring signals are provided in digital form and can therefore be transmitted over a long distance without losing accuracy.

The LEVELMETER 2000 serves as

- display- and service-unit.
- interface between the measuring instruments (RS485) and a PC or Laptop (RS232).  
**Not compatible with instruments of the BlueSYSTEM-Family!**
- service instrument for calibration (ZEROTRONIC-sensors only), and **changing addresses of the sensors** and measuring instruments connected (see chapter 3).



## 2.3 MEASUREMENT-ANALYSIS WITH A BLUEMETER SIGMA

The BlueMETER SIGMA is an intelligent digital display unit developed by WYLER AG for the inclination measuring instrument BlueLEVEL and the ZEROTRONIC sensors. Besides the excellent measuring accuracy the BlueLEVEL instruments and the ZEROTRONIC-sensors supply a fully digital signal for transmitting these over long distances without any loss of quality.

The BlueMETER SIGMA is

- a display unit
- an interface between instrument and PC/Laptop

On the BlueMETER SIGMA various parameters may be set or changed, such as:

- Measuring units
- Port definition (Port)
- Filter-settings
- Relative base length etc.



It is possible to send measured data via a RS 232 port to a printer, a PC/Laptop or the WYLER-software wylerCHART, wylerDYNAM and wylerSPEC. Using the software wylerINSERT measurement values can be inserted into other programs like Excel.

Most important features of the BlueMETER SIGMA:

- Compact and pleasant design in aluminium housing.
- Wireless data transmission based on the internationally approved Bluetooth™-standard
- Large LCD display
- Display showing the automatically recognized instruments connected
- Powered by standard 1.5 V batteries type "C"
- In compliance with CE regulations and all applicable EMC regulations

The BlueMETER SIGMA offers the possibility of displaying the measuring value of single sensors or measuring instruments or also the difference between two sensors or instruments.

The following display settings are basically possible:

- measuring with one of several instruments connected to port „A“
- measuring with one of several instruments connected to port „B“
- differential measurement between two instruments connected to the ports „A“ and „B“
- Simultaneous display of one each of several instruments connected to the ports „A“ and „B“

## 2.4 wylerDYNAM / The measuring-software for ZEROTRONIC-sensors

The wylerDYNAM software was developed for calculating and displaying static and dynamic inclinations and profiles under MICROSOFT WINDOWS. With the software wylerDYNAM all the sensors and instruments of the ZEROTRONIC-family can be operated. With the wylerDYNAM software the data of the connected sensors can be sampled, computed and displayed in various kind of forms or they can be transmitted. Every one of the connected sensors is a so called „Sensor measuring channel“ which has to be named and can be addressed correspondingly.

The integrated software modules allow the performing of a number of measuring tasks without knowledge of software programming. Simple tasks like computing the difference between two sensors or sophisticated jobs like the compensation of an acceleration from the measured angle can be performed easily.

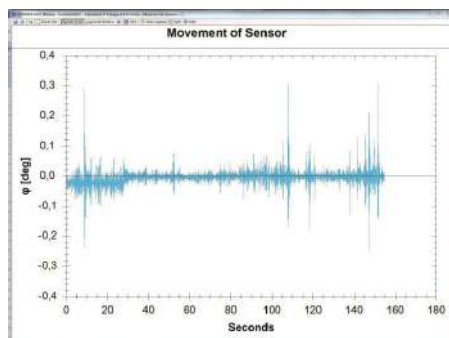

The measured data can be displayed in numerical or graphical form on a computer monitor, sent to a connected printer, saved in files on hard disc or floppy or sent to a serial output port.

The software module ANALYZER allows to open the files with the saved data and display the data again in numerical or graphical form on the monitor.

### Remark:

It is mandatory to use a T/C or MultiTC as an interface between the instruments and the PC/Laptop!



### 3. CHANGING ADDRESSES OF THE SENSORS AND MEASURING INSTRUMENTS CONNECTED

#### 3.1 LEVELMETER 2000

##### 3.1.1 PRINCIPAL DESCRIPTION OF THE LEVELMETER 2000

The LEVELMETER 2000 was designed by WYLER AG, Switzerland as an intelligent display and measuring unit in connection with the digitized sensor family ZEROTRONIC. The LEVELMETER 2000 is also useful as a display unit for the measuring instruments MINILEVEL and LEVELTRONIC NT. Besides the excellent measuring performance the specialty of the ZEROTRONIC sensors and the instruments MINILEVEL and LEVELTRONIC NT is the use of the digital technology. This allows transmitting the measuring signals over long distances without any loss of accuracy. With the LEVELMETER 2000 all the sensors and instruments of the ZEROTRONIC and the "NT" family can be operated.



The LEVELMETER 2000 is a

- Display unit
- Interface between Measuring instrument and PC
- Control unit for calibrating (ZEROTRONIC sensors only) and identifying/addressing the connected sensors and instruments

On the LEVELMETER 2000 the following parameters may be set or changed:

- Measuring unit
- Sensor address/port
- Type of damping filter
- Base length relative, and many more

The LEVELMETER 2000 is fully interchangeable with all other WYLER measuring instruments having installed a digital sensor unit (Exceptions: BlueLEVEL and BlueLEVEL BASIC). All the relevant data, such as

- Calibration data
- Sensor address
- ZERO point etc.

are stored at the respective sensor heads. Through the RS 232 port the measuring data may be transmitted to a PC/Laptop or to an other outlet as well as to the Measuring software LEVELSOFT of WYLER.

##### 3.1.2 SELECTING A SENSOR OR AN INSTRUMENT

With the LEVELMETER 2000 the possibility exists to display the measured values of individual sensors, respectively instruments connected, or the difference between two connected sensors. In case of the differential measurement the two sensors must be connected to the two ports A and B. It is not possible to measure the difference of two sensors connected to the same port.

**Basically the following set-up is possible:**

- Display the value of one of several sensors connected to port A
- Display the value of one of several sensors connected to port B
- Display the differential value between sensors connected to port A and port B

For choosing the measuring mode and the address of the sensors connected the **▲ ON/MODE** key must be pressed repeatedly until the selection pointer is below **SENSOR** and accepted by pressing **■ ENTER**. The possibilities "Port A", "Port B", "Port A-B" or "Port A B" may be selected by applying the key **▲/▼ ZERO/SELECT "+/-"**. The desired selection can be accepted by pressing **■ ENTER**. After this the LEVELMETER 2000 is looking for all the connected sensors respectively their address. Up to 255 sensors may be connected. The address of the first sensor will be displayed flashing. During the searching procedure the frame of the „Sensor address“ will flash in circular motion below the selected port.

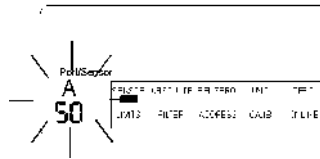

If more than one sensor is connected to the port A, the one desired can be selected by pressing **▲/▼ ZERO/SELECT** and confirmed with **■ ENTER**. In case of differential measurement between two sensors the same procedure must be repeated for port B.

After pressing **■ ENTER** the respective measurement starts.

### 3.1.3 CHANGING OF SENSOR ADDRESS

Only the **one sensor** of which the address must be changed is allowed to be connected either on port A or B.

Move the position indicator to the position **ADDRESS** by repeatedly pressing the key **▲ ON/MODE** and confirm the setting with **■ ENTER**. If only one sensor is connected as described above the respective port and address number is displayed flashing.

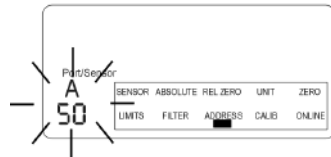

**Remarks:** If more than one sensor is connected, the error message **ERROR 5** is displayed. (More than one sensor found)

Using the keys **▲/▼ ZERO/SELECT** the new address can be entered and confirmed by pressing **■ ENTER**. If the procedure was successful the measurement starts with the newly given address.

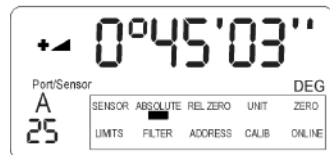

Addresses of **Zerotronic sensors** may be chosen between no. 1 and no. 254  
 Addresses of **Measuring instruments** (Minilevel NT, Leveltronic NT) may only be chosen between no. 1 and no. 32  
 The address no 255 is reserved for service purposes and should not be used.

Limitations when using **wireless transmission**:  
 Only instruments and sensors with the **address 1.....8** can be used.

The following error messages are possible:

- ERROR 4** No sensor address found
- ERROR 5** More than one sensor found
- ERROR 6** Changing of sensor address was not successful

### 3.2 BLUEMETER SIGMA

#### 3.2.1 PRINCIPAL DESCRIPTION OF THE BLUEMETER SIGMA

The new **BlueMETER SIGMA** has been developed as a successor respectively replacement of the two display units LEVELMETER 2000 and BlueMETER. With the BlueMETER SIGMA the measuring data can be transmitted via cable or wireless to a PC/Laptop. The BlueMETER SIGMA is compatible with WyBus. Therefore a wide range of measuring instruments and sensors can be read, such as

- the measuring instruments of the BlueSYSTEM family
- ZEROTRONIC sensors
- ZEROMATIC 2/1 and 2/2
- MINILEVEL NT
- LEVELTRONIC NT



The BlueMETER SIGMA serves as

- a display unit
- an interface between instruments and PC/Laptop

On the BlueMETER SIGMA various parameters, such as

- measuring unit
- measuring mode
- relative base length                      etc.

can be changed or adjusted.

#### 3.2.2 SELECTING A SENSOR OR AN INSTRUMENT

With the BLUEMETER SIGMA the possibility exists to display the measured values of individual sensors, respectively instruments connected, or the difference between two connected sensors. In case of the differential measurement the two sensors must be connected to the two ports A and B. It is not possible to measure the difference of two sensors connected to the same port.

**Basically the following set-up is possible:**

- Display the value of one of several sensors connected to port A
- Display the value of one of several sensors connected to port B
- Display the differential value between sensors connected to port A and port B

### 3.2.3 CHANGING OF SENSOR ADDRESS

Only the **one sensor** of which the address must be changed is allowed to be connected either on port A or B.

Press the key **▲ ON/MODE**, to make the menu visible. Using the keys **▲/▼ ZERO/SELECT** to choose the menu „Options“ and confirm with **■ ENTER**. Select now in the menu „Options“ by means of the key **▲/▼ ZERO/SELECT** the menu item „Auto Address“. With the key **▲/▼ ZERO/SELECT** the setting have to be changed to „OFF“. Now the measured value appears on the display again.



By means of the keys **▲ ON/MODE** and **▲/▼ ZERO/SELECT** choose the menu item „Set Address“. With the keys **▲/▼ ZERO/SELECT** the desired address can be set and confirmed with **■ ENTER**.



The address of the sensor is changed now. The serial number, in our example P0213, remains the same.



## 4. INTERFACES ZEROTRONIC-SENSORS TO PC/LAPTOP DISPLAY OF THE VALUES MEASURED WITH A PC / LAPTOP CONNECTED VIA A MULTITC (TRANSCIVER/CONVERTER) USING THE RESPECTIVE SOFTWARE

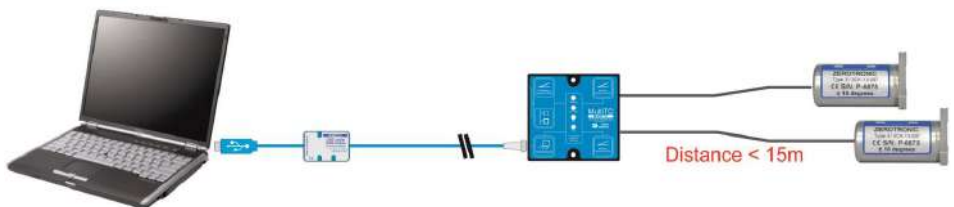

ZEROTRONIC Sensors connected to a PC or Laptop through a MultiTC (Transceiver/Converter)  
Analyze of measuring results utilizing software **wylerCHART**  
External Power supply via MultiTC.

Distance PC - T/C < 2.5 m / Distance MultiTC - sensors < 15 ... max. 20 m

## **ANNEX**

### **A TYPICAL APPLICATIONS WITH ZEROTRONIC SENSORS**

Some typical applications with ZEROTRONIC sensors and networks

- **Precision measurement on unstable objects such as:**
  - Machine tool in operation
  - Measurements on platforms at sea and vessels
  
- **Long term monitoring with data collection and -transfer**
  - Buildings
  - Construction sites
  - Bridges
  - Dams
  - Tunnels
  - Storage installations
  - Radar stations
  - Inclination measurement by driving on a road
  - Measurement of roads and tunnels profiles in longitudinal direction
  
- **Calibration**
  - Basic calibration of robotic installations
  - Adjustment of radar and antenna equipment
  
- **Various**
  - Adjustment of printing machines
  - Measurement of airplane wings profiles and landing gear
  - Measurement of all kind of vehicles e.g. adjustment of driving gear and flaps on formula 1 racing cars

## B MOST IMPORTANT ZEROTRONIC SPECIFICATIONS OVERVIEW

### B1 ZEROTRONIC 3

TECHNICAL SPECIFICATIONS	ZEROTRONIC 3				TECHNISCHE SPEZIFIKATIONEN
Measuring range	$\pm 0.5^\circ$	$\pm 1^\circ$	$\pm 10^\circ$	$\pm 30^\circ$	Messbereich
Limits of error within 24 hours ( $T_A = 20^\circ\text{C}$ ) • ZERO-POINT (Drift)	$0.070\% M_E$ = 1.26 arcsec	$0.050\% M_E$ = 1.8 arcsec	$0.015\% M_E$ = 5.4 arcsec	$0.010\% M_E$ = 10.8 arcsec	Fehlergrenze innerhalb von 24 Stunden ( $T_A = 20^\circ\text{C}$ ) • NULLPUNKT (Drift)
Limits of error within 6 months ( $T_A = 20^\circ\text{C}$ ) • ZERO-POINT (Drift)	$0.170\% M_E$ = 3.06 arcsec	$0.140\% M_E$ = 5.04 arcsec	$0.055\% M_E$ = 19.8 arcsec	$0.030\% M_E$ = 32.4 arcsec	Fehlergrenze innerhalb von 6 Monaten ( $T_A = 20^\circ\text{C}$ ) • NULLPUNKT (Drift)
• GAIN	$0.250\% M_W$	$0.250\% M_W$	$0.060\% M_W$	$0.050\% M_W$	• VERSTÄRKUNG
• Base value	+ 1 arcsec	+ 1.5 arcsec	+ 3.6 arcsec	+ 5.4 arcsec	• Sockelbetrag
Temperature error / °C ( $\varnothing 10^\circ\text{C}$ ) ( $-40^\circ\text{C} \leq T_A \leq 85^\circ\text{C}$ ) • ZERO-POINT (Drift)	$0.060\% M_E$ = 1.08 arcsec	$0.040\% M_E$ = 1.44 arcsec	$0.008\% M_E$ = 2.88 arcsec	$0.005\% M_E$ = 5.40 arcsec	Temperaturkoeffizient / °C ( $\varnothing 10^\circ\text{C}$ ) ( $-40^\circ\text{C} \leq T_A \leq 85^\circ\text{C}$ ) • NULLPUNKT (Drift)
• GAIN	$0.200\% M_W$	$0.200\% M_W$	$0.030\% M_W$	$0.020\% M_W$	• VERSTÄRKUNG
• Base value, if $T_A < 10^\circ\text{C}$ or $T_A > 30^\circ\text{C}$	+ 2 arcsec	+ 3 arcsec	+ 6 arcsec	+ 6.5 arcsec	• Sockelbetrag, wenn $T_A < 10^\circ\text{C}$ or $T_A > 30^\circ\text{C}$
Resolution ( $T_A = 20^\circ\text{C}$ )	/ arcsec	/ arcsec	/ arcsec	/ arcsec	Auflösung ( $T_A = 20^\circ\text{C}$ )
sampling time: 0.1 sec 1 value moving average over 10 values	0.738 0.360	0.900 0.360	7.20 1.80	21.6 6.48	Abtastdauer: 0.1 sec 1 Wert gleitender Mittelwert über 10 Werte
sampling time: 1 sec 1 value moving average over 10 values	0.360 0.180	0.360 0.180	1.80 0.72	6.48 3.24	Abtastdauer: 1 sec 1 Wert gleitender Mittelwert über 10 Werte
sampling time: 8 sec 1 value moving average over 10 values	0.126 0.108	0.216 0.216	0.72 0.72	3.24 3.24	Abtastdauer: 8 sec 1 Wert gleitender Mittelwert über 10 Werte
Repetition is included in Resolution					Wiederholbarkeit ist in Auflösung enthalten

TECHNICAL SPECIFICATIONS	ZEROTRONIC 3 HTR (High Temperature Range)				TECHNISCHE SPEZIFIKATIONEN
Measuring range	$\pm 0.5^\circ$	$\pm 1^\circ$	$\pm 10^\circ$	$\pm 30^\circ$	Messbereich
Temperature error / °C ( $\varnothing 10^\circ\text{C}$ ) ( $-40^\circ\text{C} \leq T_A \leq 85^\circ\text{C}$ ) • ZERO-POINT (Drift)	$0.012\% M_E$ = 0.216 arcsec	$0.008\% M_E$ = 0.288 arcsec	$0.0016\% M_E$ = 0.576 arcsec	$0.001\% M_E$ = 1.080 arcsec	Temperaturkoeffizient / °C ( $\varnothing 10^\circ\text{C}$ ) ( $-40^\circ\text{C} \leq T_A \leq 85^\circ\text{C}$ ) • NULLPUNKT (Drift)
• GAIN	$0.040\% M_W$	$0.040\% M_W$	$0.006\% M_W$	$0.004\% M_W$	• VERSTÄRKUNG
• Base value, if $T_A < 10^\circ\text{C}$ or $T_A > 30^\circ\text{C}$	+ 2 arcsec	+ 3 arcsec	+ 6 arcsec	+ 6.5 arcsec	• Sockelbetrag, wenn $T_A < 10^\circ\text{C}$ or $T_A > 30^\circ\text{C}$
All other values as ...	... ZEROTRONIC 3				Alle anderen Werte wie ...
$M_E$ = full-scale (mainly drift related) $M_W$ = measured value (mainly gain related) $T_A$ = ambient temperature					$M_E$ = Messbereichsendwert (hauptsächlich Drift bezogen) $M_W$ = Mesowert (hauptsächlich auf Verstärkung bezogen) $T_A$ = Umgebungstemperatur

## B2 ZEROTRONIC C

TECHNICAL SPECIFICATIONS	ZEROTRONIC C				TECHNISCHE SPEZIFIKATIONEN
Measuring range	±10°	±30°	±45°	±60°	Messbereich
Limits of error within 24 hours ( $T_A = 20^\circ\text{C}$ ) • ZERO-POINT (Drift)	0.015% $M_E$ = 5.4 arcsec	0.008% $M_E$ = 8.64 arcsec	0.005% $M_E$ = 8.1 arcsec	0.005% $M_E$ = 10.8 arcsec	Fehlergrenze innerhalb von 24 Stunden ( $T_A = 20^\circ\text{C}$ ) • NULLPUNKT (Drift)
Limits of error within 6 months ( $T_A = 20^\circ\text{C}$ ) • ZERO-POINT (Drift)	0.085% $M_E$ = 30.6 arcsec	0.050% $M_E$ = 54.0 arcsec	0.040% $M_E$ = 64.8 arcsec	0.035% $M_E$ = 75.6 arcsec	Fehlergrenze innerhalb von 6 Monaten ( $T_A = 20^\circ\text{C}$ ) • NULLPUNKT (Drift)
• GAIN	0.080% $M_W$	0.030% $M_W$	0.030% $M_W$	0.027% $M_W$	• VERSTÄRKUNG
• Base value	+ 4 arcsec	+ 6 arcsec	+ 10 arcsec	+ 12 arcsec	• Sockelbetrag
Temperature error / °C ( $\varnothing 10^\circ\text{C}$ ) ( $-40^\circ\text{C} \leq T_A \leq 85^\circ\text{C}$ ) • ZERO-POINT (Drift)	0.011% $M_E$ = 3.96 arcsec	0.005% $M_E$ = 5.4 arcsec	0.008% $M_E$ = 8.1 arcsec	0.005% $M_E$ = 8.64 arcsec	Temperaturkoeffizient / °C ( $\varnothing 10^\circ\text{C}$ ) ( $-40^\circ\text{C} \leq T_A \leq 85^\circ\text{C}$ ) • NULLPUNKT (Drift)
• GAIN	0.015% $M_W$	0.020% $M_W$	0.025% $M_W$	0.030% $M_W$	• VERSTÄRKUNG
• Base value, if $T_A < 10^\circ\text{C}$ or $T_A > 30^\circ\text{C}$	+ 6.5 arcsec	+ 7 arcsec	+ 11 arcsec	+ 14 arcsec	• Sockelbetrag, wenn $T_A < 10^\circ\text{C}$ or $T_A > 30^\circ\text{C}$
Resolution ( $T_A = 20^\circ\text{C}$ )	/ arcsec	/ arcsec	/ arcsec	/ arcsec	Auflösung ( $T_A = 20^\circ\text{C}$ )
sampling time: 0.1 sec 1 value moving average over 10 values	18.0 7.2	23.8 7.6	29.2 8.1	54.0 10.8	Abtastdauer: 0.1 sec 1 Wert gleitender Mittelwert über 10 Werte
sampling time: 1 sec 1 value moving average over 10 values	5.4 2.2	6.5 3.2	8.1 3.2	8.6 4.3	Abtastdauer: 1 sec 1 Wert gleitender Mittelwert über 10 Werte
sampling time: 8 sec 1 value moving average over 10 values	2.9 2.9	3.2 3.2	4.9 3.2	6.5 4.3	Abtastdauer: 8 sec 1 Wert gleitender Mittelwert über 10 Werte
Repetition is included in Resolution					Wiederholbarkeit ist in Auflösung enthalten

TECHNICAL SPECIFICATIONS	ZEROTRONIC C HTR (High Temperature Range)				TECHNISCHE SPEZIFIKATIONEN
Measuring range	±10°	±30°	±45°	±60°	Messbereich
Temperature error / °C ( $\varnothing 10^\circ\text{C}$ ) ( $-40^\circ\text{C} \leq T_A \leq 85^\circ\text{C}$ ) • ZERO-POINT (Drift)	0.0022% $M_E$ = 0.792 arcsec	0.001% $M_E$ = 1.08 arcsec	0.001% $M_E$ = 1.62 arcsec	0.0008% $M_E$ = 1.728 arcsec	Temperaturkoeffizient / °C ( $\varnothing 10^\circ\text{C}$ ) ( $-40^\circ\text{C} \leq T_A \leq 85^\circ\text{C}$ ) • NULLPUNKT (Drift)
• GAIN	0.003% $M_W$	0.004% $M_W$	0.005% $M_W$	0.006% $M_W$	• VERSTÄRKUNG
• Base value, if $T_A < 10^\circ\text{C}$ or $T_A > 30^\circ\text{C}$	+ 6.5 arcsec	+ 7 arcsec	+ 11 arcsec	+ 14 arcsec	• Sockelbetrag, wenn $T_A < 10^\circ\text{C}$ or $T_A > 30^\circ\text{C}$
All other values as ...	... ZEROTRONIC C				Alle anderen Werte wie ...
$M_E$ = full-scale (mainly drift related) $M_W$ = measured value (mainly gain related) $T_A$ = ambient temperature					$M_E$ = Messbereichsendwert (hauptsächlich Drift bezogen) $M_W$ = Mesowert (hauptsächlich auf Verstärkung bezogen) $T_A$ = Umgebungstemperatur

### B3 DETAILED SPECIFICATIONS OF ZEROTRONIC-SENSORS

#### B3.1 GENERAL

- RS485 Bus-Interface
- Automatic baud rate detection 4'800 .. 115'200 baud
- 32 Sensors on the same RS485 bus
- Optional **analogue** output (corresponding 4...20mA current interface available at WYLER)

#### B3.2 PIN-ASSIGNMENT

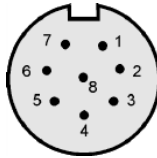

Pin Number	Pin Name	Pin Type	Pin Function
1			
2	VSS	Input/Output	Ground
3	VDD	Input	Regulated Power 5V DC
4	RTA	Input/Output	RS485-Line A
5	RTB	Input/Output	RS485-Line B
6	PWM*	Output	PWM-Signal (0.1 x (VDD-VSS) ⇔ - Fullscale) (0.9 x (VDD-VSS) ⇔ + Fullscale)
7	RTS	Output O.C.	Request to send
8			

\* For ZEROTRONIC 3 only



### B3.3 ABSOLUTE MAXIMUM RATINGS \*)

- Supply Voltage VDD with respect to VSS 0V to + 7V
- Input Voltage ENA,ENB and RTS with respect to VSS - 0.5V to VDD + 0.5V
- Input Voltage RTA and RTB with respect to VSS - 14V to + 14V
- Ambient temperature under bias - 55°C to + 95°C
- Storage temperature - 55°C to + 95°C

**\*) Notice:** Stresses above those listed under „Maximum Ratings“ may cause permanent damage to the device

### B3.4 DC CHARACTERISTICS ZEROTRONIC-SENSOR

Operation Conditions: 3.6V ≤ VDD ≤ 5.5V, -40°C ≤ TA ≤ 85°C

Characteristic	Symbol	Min	Type	Max	Unit	Conditions
Supply voltages and currents						
• Supply Voltage Type 3	Vdd	3.6	5.0	5.5	V	
• Supply Voltage Type C	Vdd	4.5	5.0	5.5	V	
Supply Current	Idd		13.0	20	mA	Iod = 0
Encoder inputs ENA & ENB						
• Input Low Voltage	Vil	0.8			V	0V ≤ Vin ≤ Vdd
• Input High Voltage	Vih			2.4	V	
• Input Current	Iin	- 0.5		0.5	mA	
RTS output (OpenCollector)						
• Output Low Voltage	Vol			0.4	V	Iol = - 20 mA
• Output High Voltage	Voh			Vdd + 0.5	V	
RS485 parameter RTA & RTB Common Mode Input Voltage	Vcm	- 7		12	V	
Receiver Input Hysteresis	Vth		70		mV	Vcm = 0V
Receiver Input Resistance	Rin	12			kΩ	- 7V ≤ Vcm ≤ + 12V
Differential Driver Output Voltage	Vod	1.5		Vdd	V	R = 27Ω
Driver Output Current	Iod	55			mA	

### B3.5 RS485-INTERFACE

Parameter	Value
• Databit	7
• Stopbit	2
• Parity	None
• Baurate	4800 to 115200 Baud

## B4 RS485 MESSAGES HOST <<< -- -->>> ZEROTRONIC

### Used set of characters

- ASCII Numbers ,0' .. ,9'
- ASCII Letters ,A' .. ,F'
- ASCII Special characters ,~'
- ASCII Control characters <CR>

### Polling mode

- Instrument will not transmit any data spontaneously
- Instrument will transmit a response only upon reception of a command
- The same data frame structure is used for commands as well as responses

### Timing of data exchange

- A command may be sent to the instrument with maximum rate (2 Stopbits) or with large intervals between the individual characters
- Immediately after receiving a command, the instrument will transmit a response
- During transmission of a response the open drain signal (RTS / Request to Send) will be held low (GND) by the instrument

### **Checksum Calculation (WYLER AG)**

Examples of e.g. command:

~~~~~011D00000000F<CR> (Command to get the actual angle value of Sensor with address 1)

~~~~~021D0000000010<CR> (Command to get the actual angle value of Sensor with address 2)

Remark: The last two characters represent the checksum.

The checksum is the sum of the 12 characters following the "~" characters.

Please bear in mind, however, that we do not add the ASCII values but the values represented by the ASCII characters.

Example: ~~~~~051D0000000013<CR> Sum of the 12 characters after the "~" = 19 (decimal)  
19 divided by 16 = 1; remainder 3 => checksum 13 (hexadecimal)

e.g. The ASCII character 'B' represents the value '11' and is therefore added up as 11.

| Decimal Value | ASCII Value |
|---------------|-------------|
| 0             | ,0'         |
| 1             | ,1'         |
| 2             | ,2'         |
| 3             | ,3'         |
| 4             | ,4'         |
| 5             | ,5'         |
| 6             | ,6'         |
| 7             | ,7'         |

| Decimal Value | ASCII Value |
|---------------|-------------|
| 8             | ,8'         |
| 9             | ,9'         |
| 10            | ,A'         |
| 11            | ,B'         |
| 12            | ,C'         |
| 13            | ,D'         |
| 14            | ,E'         |
| 15            | ,F'         |

Conversion table DECIMAL <=> BINARY <=> HEXADEC

| DECIMAL | BINARY | HEXADEC. |
|---------|--------|----------|
| 0       | 0      | 0        |
| 1       | 1      | 1        |
| 2       | 10     | 2        |
| 3       | 11     | 3        |
| 4       | 100    | 4        |
| 5       | 101    | 5        |
| 6       | 110    | 6        |
| 7       | 111    | 7        |
| 8       | 1000   | 8        |
| 9       | 1001   | 9        |
| 10      | 1010   | A        |
| 11      | 1011   | B        |

| DECIMAL | BINARY | HEXADEC. |
|---------|--------|----------|
| 12      | 1100   | C        |
| 13      | 1101   | D        |
| 14      | 1110   | E        |
| 15      | 1111   | F        |
| 16      | 10000  | 10       |
| 17      | 10001  | 11       |
| 18      | 10010  | 12       |
| 19      | 10011  | 13       |
| 20      | 10100  | 14       |
| 21      | 10101  | 15       |
| 22      | 10110  | 16       |
| 23      | 10111  | 17       |

**Command / Response data frame structure**

|          |   |
|----------|---|
| Header   | ASCII ,~' (Begin of command or response)<br>ASCII ,~' (minimum 4 of these characters must be sent)<br>ASCII ,~'<br>ASCII ,~'  |
| Address  | ASCII ,0' .. ,9' ,A' .. ,F' Bit[7..4] =>+ (Instruments resp. sensor address)<br>ASCII ,0' .. ,9' ,A' .. ,F' Bit[3..0] =>+<br>ASCII ,1' =>+  |
| Opcode   | ASCII ,0' .. ,9' ,A' .. ,F' Bit[3..0] =>+   |
| Data     | ASCII ,0' .. ,9' ,A' .. ,F' Bit[31..28] =>+<br>ASCII ,0' .. ,9' ,A' .. ,F' Bit[27..24] =>+<br>ASCII ,0' .. ,9' ,A' .. ,F' Bit[23..20] =>+<br>ASCII ,0' .. ,9' ,A' .. ,F' Bit[19..16] =>+<br>ASCII ,0' .. ,9' ,A' .. ,F' Bit[15..12] =>+<br>ASCII ,0' .. ,9' ,A' .. ,F' Bit[11..8] =>+<br>ASCII ,0' .. ,9' ,A' .. ,F' Bit[7..4] =>+<br>ASCII ,0' .. ,9' ,A' .. ,F' Bit[3..0] =>+ |
| Checksum | ASCII ,0' .. ,9' ,A' .. ,F' Bit[7..4] <=<br>ASCII ,0' .. ,9' ,A' .. ,F' Bit[3..0]   |
| Trailer  | ASCII <CR> (End of command or response)   |

**FOR ZEROTRONIC SENSORS**

| 1..6   | 7                  | 8             | 9           | 10      | 11   | 12   | 13   | 14   | 15   | 16   | 17   | 18   | 19       | 20      | 21  |   |
|--|--------------------|---------------|-------------|---------|------|------|------|------|------|------|------|------|----------|---------|---|---|
| ASCII-Characters '0'...'9' und 'A' bis 'F' ⇔ Nibble Values 0..15 |                    |               |             |         |      |      |      |      |      |      |      |      |          |         | <CR>  |   |
| HEADER   |                    | RS485 Address | Sub Address | Op code | Data |      |      |      |      |      |      |      | Checksum | Trailer |   |   |
|  |                    | 3210          | 3210        | 3210    | 3210 | 3210 | 3210 | 3210 | 3210 | 3210 | 3210 | 3210 | 3210     | 3210    | 3210  |   |
|  |                    | Dddd          | dddd        | dddd    | dddd | dddd | dddd | dddd | Dddd | dddd | dddd | dddd | dddd     | cccc    | cccc  | d=Data<br>c[7..0] =<br>Checksum of<br>data nibbles      |
|  |                    | Aaaa          | aaaa        | ssss    |      |      |      |      |      |      |      |      |          |         | a[7..0] = RS485-Address<br>s=[3..0] = Sub-Address |   |
| ReadID   | HOST to ZEROTRONIC | 0001          | 0000        | 0000    | 0000 | 0000 | 0000 | 0000 | 0000 | 0000 | 0000 | 0000 | 0000     | 0000    | 0000  |   |
|  | ZEROTRONIC to HOST | 0000          | ####        | ####    | #### | #### | #### | #### | #### | #### | #### | #### | ####     | ####    | ####  | i[11..0] = Type (3 = Type3)                             |
| WriteGateTime  | HOST to ZEROTRONIC | 1010          | 0000        | 0000    | 0011 | 1010 | 0000 | tttt | tttt | tttt | tttt | tttt | tttt     | tttt    | tttt  | t[11..0] = Time [ms]                                    |
|  | ZEROTRONIC to HOST | 0000          | ####        | ####    | #### | #### | #### | #### | #### | #### | #### | #### | ####     | ####    | ####  |   |
| Write Synch  | HOST to ZEROTRONIC | 1001          | 0000        | 0000    | 0000 | 0000 | 0000 | 0000 | 0000 | 0000 | 0000 | 0000 | 0000     | 0000    | 0000  |   |
|  | ZEROTRONIC to HOST | 0000          | ####        | ####    | #### | #### | #### | #### | #### | #### | #### | #### | ####     | ####    | ####  |   |
| WriteEEPROM  | HOST to ZEROTRONIC | 1100          | 0000        | 0000    | 0101 | 0aaa | aaaa | aaaa | aaaa | dddd | dddd | dddd | dddd     | dddd    | dddd  | a[10..0] = EEPROM-Address<br>d[7..0] = EEPROM-Data      |
|  | ZEROTRONIC to HOST | 0000          | ####        | ####    | #### | #### | #### | #### | #### | #### | #### | #### | ####     | ####    | ####  |   |
| ReadAngle(*)   | HOST to ZEROTRONIC | 1101          | 0000        | 0000    | 0000 | 0000 | 0000 | 0000 | 0000 | 0000 | 0000 | 0000 | 0000     | 0000    | 0000  |   |
|  | ZEROTRONIC to HOST | 0000          | ssss        | iiii    | Ffff | ffff | ffff | ffff | ffff | ffff | ffff | ffff | ffff     | ffff    | ffff  | s[3..0] = Sequence<br>i[3..0],f[23..0] = Angle [radian] |

Remarks: (#) = undefined / don't care

**C DETAILED SPECIFICATIONS OF THE TRANSCEIVER T/C**  
**C1 GENERAL**

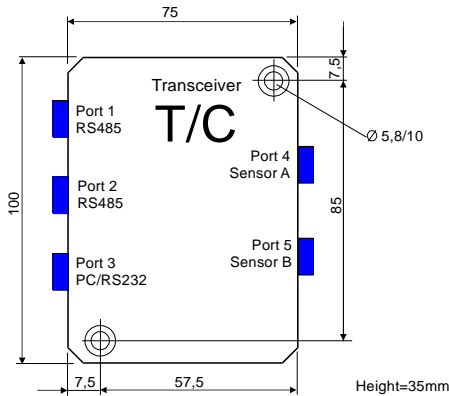

- Automatic baudrate detection 4'800 .. 57'600 baud
- Port 1 (RS485) and Port 2 (RS485): RS485 Interface for up to 32 Sensors
- Port 3 (PC/RS232): RS232 Bus-Interface
- Port 4 (Sensor A) and Port 5 (Sensor B): RS485 Interface for up to 5 Sensors each
- Ports 3 / 4 / 5 are electrically isolated Interfaces

**Distances:**

- Port 1 and Port 2 to Sensors: max. 15 Meters
- Port 485 to next T/C (Bus): max. 1200 Meters
- Port 4 and Port 5 to Sensors: max. 15 Meters
- Port 3 to PC: max. 2.5 Meters

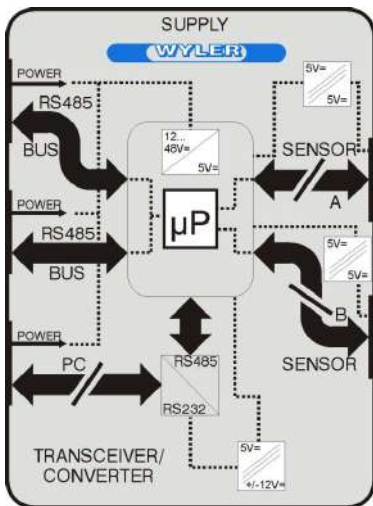

**Remarks:**

/// means: galvanic isolation

All 5 connectors are Binder Series 712, 8 pol female

| Colour of LED | Light characteristic          | Function                           |
|---------------|-------------------------------|------------------------------------|
| Yellow        | Continous                     | Ready, powered, no communication   |
| Yellow        | Intermittent 2 sec            | Hardware error (internal or cable) |
| Green         | Continous, to short intervals | Communication successful           |
| red           | Continous, to short intervals | Contact with PC, no answer on BUS  |

**Remarks:**

LED of all TC's, which are not directly connected to RS232 line (PC), change status at a speed not noticeable. In this case the LED shines yellow

## C2 PIN-ASSIGNMENT TRANSCEIVER/CONVERTER

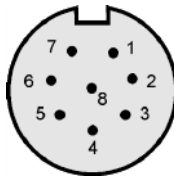

### PIN-ASSIGNMENT PORT 1 AND PORT 2

| Pin Number | Pin Name | Pin Type     | Pin Function          |
|------------|----------|--------------|-----------------------|
| 1          | VPP      | Input/Output | Unregulated Power     |
| 2          | VSS      | Input/Output | Ground                |
| 3          | VDD      | Input/Output | Regulated Power 5V DC |
| 4          | RTA      | Input/Output | RS485-Line A          |
| 5          | RTB      | Input/Output | RS485-Line B          |
| 6          | -        | -            | -                     |
| 7          | -        | -            | -                     |
| 8          | -        | -            | -                     |

### PIN-ASSIGNMENT PORT 3

| Pin Number | Pin Name | Pin Type     | Pin Function      |
|------------|----------|--------------|-------------------|
| 1          | VPP      | Input/Output | Unregulated Power |
| 2          | VSS      | Input/Output | Ground            |
| 3          | TD       | Output       | RS232-Line TD     |
| 4          | -        | -            | -                 |
| 5          | RD       | Input        | RS232-Line RD     |
| 6          | -        | -            | -                 |
| 7          | Ground   | Input/Output | RS232-Line Ground |
| 8          | -        | -            | -                 |

### PIN-ASSIGNMENT PORT 4 AND PORT 5

| Pin Number | Pin Name | Pin Type     | Pin Function          |
|------------|----------|--------------|-----------------------|
| 1          | -        | -            | -                     |
| 2          | VSS      | Input/Output | Ground                |
| 3          | VDD      | Output       | Regulated Power 5V DC |
| 4          | RTA      | Input/Output | RS485-Line A          |
| 5          | RTB      | Input/Output | RS485-Line B          |
| 6          | -        | -            | -                     |
| 7          | RTS      | Input        | Request to send       |
| 8          | -        | -            | -                     |

### C3 ABSOLUTE MAXIMUM RATINGS \*)

- Unregulated Supply Voltage  $V_{PP}$  with respect to  $V_{SS}$  0V to + 60V
- Supply Voltage  $V_{DD}$  with respect to  $V_{SS}$  0V to + 7V
- Input Voltage ENA, ENB and RTS with respect to  $V_{SS}$  - 0.5V to  $V_{DD}$  + 0.5V
- Input Voltage RTA and RTB with respect to  $V_{SS}$  - 14V to + 14V
- Ambient temperature under bias - 55°C to + 95°C
- Storage temperature - 55°C to + 95°C

**\*) Notice:**

Stresses above those listed under „Maximum Ratings“ may cause permanent damage to the device!

### C4 DC CHARACTERISTICS

Operation Conditions:  $4.5V \leq V_{DD} \leq 5.5V$ ,  $-40^{\circ}C \leq T_A \leq 85^{\circ}C$

| Characteristic                       | Symbol   | Min  | Type  | Max      | Unit      | Conditions   |
|--------------------------------------|----------|------|-------|----------|-----------|--|
| <b>Supply voltages and currents</b>  |          |      |       |          |           |  |
| • Unregulated Supply Voltage         | $V_{PP}$ | 10.0 |       | 56.0     | V         | $I_{DD} = 0$<br>$V_{PP} = 0.0V$ $I_{PP} = 0$   |
| • Regulated Supply Voltage           | $V_{DD}$ | 4.5  |       | 5.5      | V         |  |
| • Supply Current                     | $I_{PP}$ |      | 160.0 |          | MA        | $V_{PP} = 10.0V$ $I_{DD} = 0$<br>$V_{PP} = 24.0V$ $I_{DD} = 0$<br>$V_{PP} = 0.0V$ $I_{PP} = 0$ |
|                                      | $I_{DD}$ |      | 60.0  |          | MA        |  |
|                                      |          |      | 100.0 |          | MA        |  |
| <b>RTS input</b>                     |          |      |       |          |           |  |
| • Input Low Voltage                  | $V_{IL}$ | 2.4  |       | 0.8      | V         | $V_{IN} = 0.0V$  |
| • Input High Voltage                 | $V_{IH}$ |      |       |          | V         |  |
| • Input Current                      | $I_{IN}$ |      |       | 6.0      | MA        |  |
| <b>RS485 parameter RTA &amp; RTB</b> |          |      |       |          |           |  |
| • Common Mode Input Voltage          | $V_{CM}$ | - 7  |       | 12       | V         |  |
| • Receiver Input Hysteresis          | $V_{TH}$ |      | 70    |          | mV        | $V_{CM} = 0V$  |
| • Receiver Input Resistance          | $R_{IN}$ | 12   |       |          | $k\Omega$ | $- 7V \leq V_{CM} \leq + 12V$  |
| • Differential Driver Output Voltage | $V_{OD}$ | 1.5  |       | $V_{DD}$ | V         | $R = 27\Omega$   |
| • Driver Output Current              | $I_{OD}$ | 55   |       |          | mA        |  |

### C5 RS232 INTERFACE

| Parameter | Value              |
|-----------|--------------------|
| • Databit | 7                  |
| • Stopbit | 2                  |
| • Parity  | None               |
| • Baurate | 4800 to 57600 Baud |

### C6 CONFIGURATION WITH WYLER NETWORK ... RS485

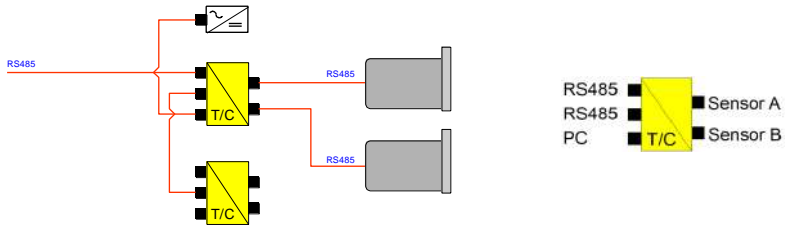

### SAMPLE ANGLE READOUT FLOWCHART (RS485)

|   |                          |                      |                      |
|---|--------------------------|----------------------|----------------------|
| <b>Initialization</b><br>(RS485-Address = 5, Sub-Address = 1,<br>Sampling-Time = 1000 ms) |                          | HOST ⇒ ZEROTRONIC    | ZEROTRONIC ⇒ HOST    |
| <b>Write Sampling-Time</b><br>GateTime = (Sampling-Time/2)-1                              | WriteGateTime(5, 1, 499) | ~~~~~051A003A01F330J | ~~~~~0510.....J      |
| <b>Measurement Loop</b>   |                          |                      |                      |
| <b>Read Angle</b>   | Angle = ReadAngle(5, 1)  | ~~~~~051D0000000013J | ~~~~~0510sifffff...J |

### C7 CONFIGURATION WITH WYLER NETWORK ... RS232

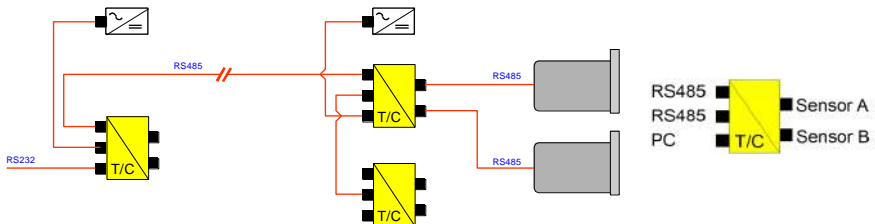

### C8 SAMPLE ANGLE READOUT FLOWCHART (RS232)

|   |                          |                           |            |
|---|--------------------------|---------------------------|------------|
| <b>Initialization</b><br>(RS485-Address = 5, Sub-Address = 1,<br>Sampling-Time = 1000 ms) |                          | HOST ⇒ T/C ⇒ ZEROTRONIC   | T/C ⇒ HOST |
| <b>Write Sampling-Time</b><br>GateTime = (Sampling-Time/2)-1                              | WriteGateTime(5, 1, 499) | ~~~~~051A003A01F330J..... | .....      |
| <b>Measurement Loop</b>   |                          |                           |            |
| <b>Read Angle</b>   | Angle = ReadAngle(5, 1)  | ~~~~~051D0000000013J..... | .....      |



**C9 CONFIGURATION WITH WYLER NETWORK AND WITH "WYLERDYNAM"**

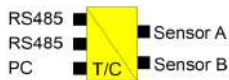
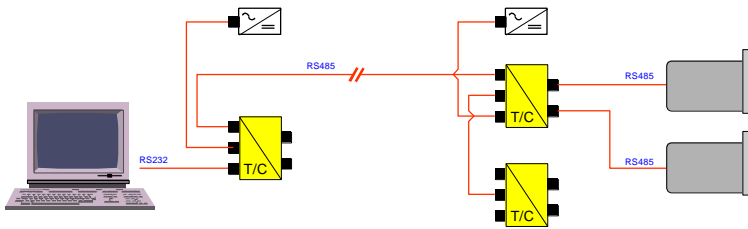

**General:**

The following specifications are valid when the data is computed by the software "wylerDYNAM" in a bus system as seen above.

**Specifications:**

The maximum sampling rate depends on the possible baudrate (given by the performance of the computer), the number of sensors connected and the type of sensor. The values below are meant to be typical values only)

| Maximum Baud rate | Maximum Sampling rate [1/sec] | Sampling Time e.g. 1 sensor connected [sec] | Sampling Time e.g. 5 sensors connected [sec] |
|-------------------|-------------------------------|---|--|
| 57600             | 90                            | 0.011                                       | 0.055  |
| 28800             | 45                            | 0.022                                       | 0.111  |
| 19200             | 30                            | 0.033                                       | 0.166  |
| 9600              | 15                            | 0.066                                       | 0.333  |

## D INTRODUCTION MULTI TC

### D1 DESCRIPTION OF THE INTERFACE MULTI TC

The MultiTC has been developed by WYLER SWITZERLAND as an alternative interface instead of the BlueMETER SIGMA for the electronic inclination measuring instruments with digital measuring unit. Besides the excellent measuring precision these measuring instruments feature the advantage that the measuring signals are captured in digital form and can thus be transmitted over long distances without any loss of accuracy.

The MultiTC can be used in combination with all WYLER inclination measuring instruments with digital measuring unit. All relevant data like

- calibration data
- address of the instrument

are memorised in the respective measuring instruments. By the RS 232 interface the MultiTC enables the transmission of the measuring values to a PC/Laptop and to the measuring software wylerSPEC, wylerDYNAM or wylerINSERT

Advantages compared to the BlueMETER SIGMA

- simple configuration
- reduced costs

Disadvantages compared to the BlueMETER SIGMA

- no display of the measuring values
- change of the address of a measuring instrument not possible
- a PC with measuring software wylerSPEC, wylerDYNAM or wylerINSERT is indispensable

### D2 GENERAL

The MultiTC links WYLER measuring instrument with RS 485 signal output to a PC or Laptop and provides stabilised voltage supply at 5 Volt.

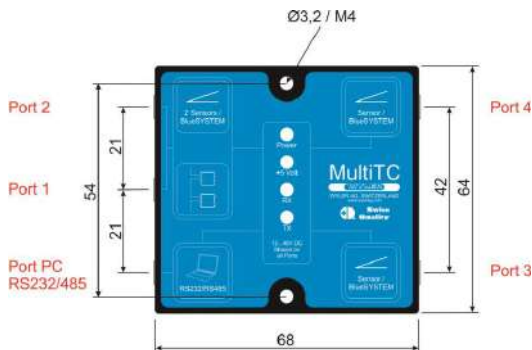

Automatic baud rate detection  
4'800 / 9600 / 19200 / 38400 /  
57600 baud  
(first two "tildes" are deciding)

#### Remarks:

- An external power supply unit 12...24 Volt DC is necessary

### D3 POSSIBLE CONFIGURATIONS (EXAMPLE WITH ZEROTRONIC-SENSORS)

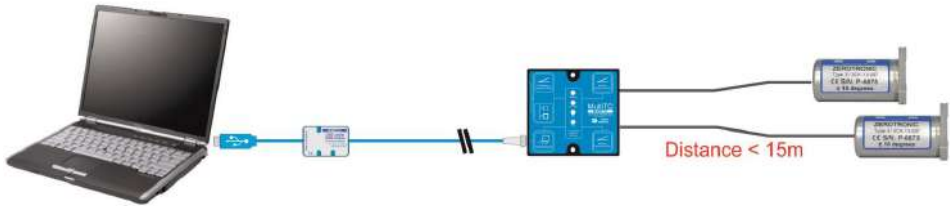

### D4 PIN-ASSIGNMENT MULTITC

RS485

Binder Series 712 / 8 pol.  
(female)

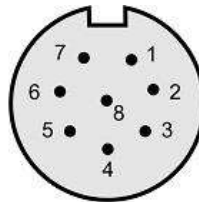

#### PIN-ASSIGNMENT ALL RS485-PORTS

| Pin Number | Pin Name | Pin Type     | Pin Function      |
|------------|----------|--------------|-------------------|
| 1          | VPP      | Power in     | Unregulated Power |
| 2          | VSS      | GND          | Ground            |
| 3          | VDD      | Power out    | Power +5V         |
| 4          | RTA      | Input/Output | RS485-Line A      |
| 5          | RTB      | Input/Output | RS485-Line B      |
| 6          | -        | -            | -                 |
| 7          | -        | -            | -                 |
| 8          | KEY*     | Input        | Trigger Key       |

\* Measuring can be triggered via „Key-Cable“ / WY 065-025-KEY

## D5 ABSOLUT MAXIMUM RATINGS \*)

- Unregulated Supply Voltage  $V_{PP}$  with respect to  $V_{SS}$  (RESPECT POLARITY) **0V to + 32V**
- Supply Voltage  $V_{DD}$  with respect to  $V_{SS}$  **0V to + 6.5V**
- Input Voltage  $EN_A, EN_B$  and  $RTS$  with respect to  $V_{SS}$  **- 0.5V to  $V_{DD} + 0.5V$**
- Input Voltage  $RTA$  and  $RTB$  with respect to  $V_{SS}$  **- 14V to + 14V**
- Ambient temperature under bias **- 40°C to + 85°C**
- Storage temperature **- 40°C to + 85°C**

### \*) Notice:

Stresses above those listed under „Maximum Ratings“ may cause permanent damage to the device!

## D6 DC CHARACTERISTICS

Operation Conditions:  $4.5V \leq V_{DD} \leq 5.5V$ ,  $-40^\circ C \leq T_A \leq 85^\circ C$

| Characteristic                             | Symbol   | Min  | Type  | Max      | Unit       | Conditions   |
|--|----------|------|-------|----------|------------|--|
| <b><u>Supply voltages and currents</u></b> |          |      |       |          |            |  |
| • Unregulated Supply Voltage               | $V_{PP}$ | 10.0 |       | 32.0     | V          | $I_{DD} = 0$<br>$V_{PP} = 0.0V$ $I_{PP} = 0$   |
| • Regulated Supply Voltage                 | $V_{DD}$ | 4.5  |       | 5.5      | V          |  |
| • Supply Current                           | $I_{PP}$ |      | 160.0 |          | MA         | $V_{PP} = 10.0V$ $I_{DD} = 0$<br>$V_{PP} = 24.0V$ $I_{DD} = 0$<br>$V_{PP} = 0.0V$ $I_{PP} = 0$ |
|  |          |      | 60.0  |          | MA         |  |
|  |          |      | 100.0 |          | MA         |  |
| <b><u>KEY input</u></b>                    |          |      |       |          |            |  |
| • Input Low Voltage                        | $V_{IL}$ | 2.4  |       | 0.8      | V          | $V_{IN} = 0.0V$  |
| • Input High Voltage                       | $V_{IH}$ |      |       | V        |            |  |
| • Input Current                            | $I_{IN}$ |      |       | 2.0      | MA         |  |
| <b><u>RS485 parameter</u></b>              |          |      |       |          |            |  |
| <b><u>RTA &amp; RTB</u></b>                |          |      |       |          |            |  |
| • Common Mode Input Voltage                | $V_{CM}$ | - 7  |       | 12       | V          |  |
| • Receiver Input Hysteresis                | $V_{TH}$ |      | 70    |          | mV         | $V_{CM} = 0V$  |
| • Receiver Input Resistance                | $R_{IN}$ | 12   |       |          | k $\Omega$ | $- 7V \leq V_{CM} \leq + 12V$  |
| • Differential Driver Output Voltage       | $V_{OD}$ | 1.5  |       | $V_{DD}$ | V          | $R = 27\Omega$   |
| • Driver Output Current                    | $I_{OD}$ | 55   |       |          | mA         |  |

## D7 RS232-INTERFACE

| Parameter  | Value                                 |
|------------|---------------------------------------|
| • Databit  | 7                                     |
| • Stopbit  | 2                                     |
| • Parity   | None                                  |
| • Baudrate | 4800 to 57600 Baud (autom. detection) |

**E SPECIFICATIONS BLUETC**  
**E1 BLUETC WITH WIRELESS MODULE (DETAILS)**  
**E1.1 GENERAL**

The BlueTC with radio transmission was developed as an **interface** for connecting ZEROTRONIC sensors to a PC/Laptop. The data transfer is via cables or via radio.

Functions in connection with sensors ZEROTRONIC

All the relevant data such as

- Calibration data
- Instrument's address

are stored in the instrument's memory. It is possible to send measured data via RS 232/422/485 ports to a PC/Laptop or another output device

**E1.2 TYPICAL CONFIGURATIONS WITH BLUETC**

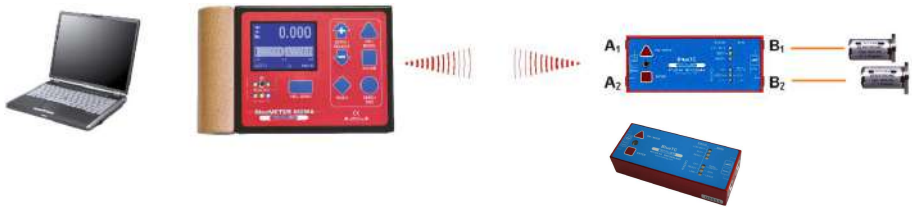

- A<sub>1</sub>** • CONNECTION TO PC OR LAPTOP  
**A<sub>2</sub>** • CONNECTION OF AN EXTERNAL POWER SUPPLY

- B<sub>1</sub>** • CABLE CONNECTION FOR BLUELEVEL INSTRUMENT OR **ZEROTRONIC** SENSOR  
**B<sub>2</sub>** • CONNECTION OF AN EXTERNAL POWER SUPPLY

**REMARKS**

AN EXTERNAL POWER SUPPLY MAY BE CONNECTED TO ANY FREE CONNECTING PORT

## E2 INITIAL STARTUP OF THE BLUETC

**Please read the manual carefully before working with the BlueTC for the first time.**

### Starting the BlueTC.

Press the key <ON/MODE> continuously until all 6 LED's are illuminated then release the key

- The LED „READY“ in **STATUS** is flashing rapidly
- The green LED „READY“ in **RADIO** is blinking so many times as instruments are connected in the radio mode (inclusive own address)
- During measurements and during data transmission via radio the **blue LED "LINK"** under **RADIO** is on

### Wireless mode

When the instrument is in the ON-mode and the radio mode is deactivated then the light [Radio ON/OFF] is illuminated **red**.

### Deactivating the automatic instrument shut off of the BlueTC:

When pressing the **ON/MODE** key at the **starting of the instrument** longer than 10 seconds all LED's start blinking and the **automatic shut off** is **deactivated**. Normally as well as in battery mode the instrument is automatically shut off after 60 minutes.

#### Exception:

When the BlueTC is connected to an external power supply the instrument never shuts off automatically.

### Turning off the BlueTC:

For **shutting off** the BlueTC the key **ON/MODE** must be pressed continuously until all 6 LED's are on.

## E2.1 COMBINE A GROUP OF INSTRUMENTS TO A MEASUREMENT GROUP USING THE FUNCTION „JOIN“ IN RADIO TRANSMISSION MODE

When instruments e.g. two BlueTC are connected via a BlueMETER SIGMA to a Laptop, (one TC with two ZEROTRONIC sensors) they should be connected together to a measuring group. The function „JOIN“ must be applied.

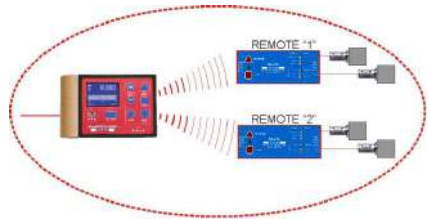

### **IMPORTANT:**

In case more than two instruments should be part of a group e.g. one BlueMETER SIGMA „Host“ and two BlueTC Client "1"+ Client "2" **they must be joined step by step with only two units joined at the time.**

In such a case it makes sense to group first the BlueMETER SIGMA „Host“ with the BlueTC Client "1" and then BlueMETER SIGMA „Host“ with the BlueTC Client "2". All the instruments in the same group communicate together on the same level.

### E2.1.1 PROCEDURE FUNCTION „JOIN“

1. **Switch ON** the BlueTC's to be part of the group by using the key <ON/MODE> until all 6 LED's are illuminated, release the key.
2. The menu must be activated (see above)
3. The instruments to be connected must be set to the mode **JOIN**. The <ON/MODE> key must repeatedly be pressed until in the display the mode **[JOIN]** is seen. Confirm with <ENTER>
3. Searching and connecting  
Both instruments are searching the area in order to find a partner instrument. Both instruments are alternately in the mode „INQUIRY“ and „DISCOVERABLE“.

*INQUIRY-, respectively. DISCOVERABLE-Mode:*

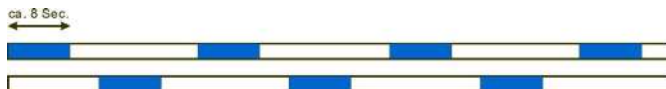

During this searching mode the green LED is on both instruments ON continuously. The search mode remains on until the process is cancelled either:

- by using the key <ENTER>
- or
- until a radio connection has taken place between the two instruments.

**Remarks:** The searching mode may go on for several minutes in bad communication conditions

As soon as the instruments are successfully joined it is visualized by a rapid blinking (4 to 5 times per second) of the green LED's on both instruments. The joining can now be activated by

- using the <ENTER> key on one of the instruments.
- or
- the whole process may be cancelled by pressing the key <ON/MODE>.

The green LED "READY" under **RADIO** is blinking in short intervals as many times as instruments are in the same group communicating. (inclusive the own address)

## E2.2 UNHINGE AN INSTRUMENT IN THE RADIO MODE FROM A GROUP, USING THE FUNCTION „LEAVE“

Every instrument may be disconnected from an active measuring group.

### E2.2.1 PROCEDURE „LEAVE“

1. Press the <ON/MODE> key of the instrument to be disconnected until all 6 LED's are illuminated, release the key.
2. The menu must be activated (see above)
3. The <ON/MODE> key must repeatedly be pressed until in the display the mode [LEAVE] is seen. The LED "LEAVE" shines blue. Confirm with <ENTER>
4. The green LED "READY" under RADIO is blinking one time. The instrument has left the measuring group

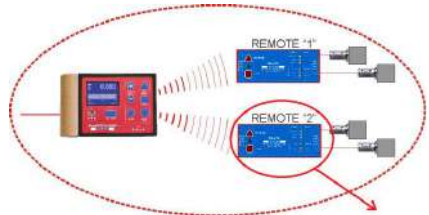

## E3 RENEWED CONNECTION OF A MEASURING GROUP

After a measuring group has been stopped e.g. after the termination of a measurement, the group of instruments remains intact. This means the process JOIN must not be repeated.



## E4 TYPICAL CONFIGURATIONS WITH BLUETC

Configuration with Laptop connected via BlueMETER SIGMA and BlueTC to ZEROTRONIC sensors

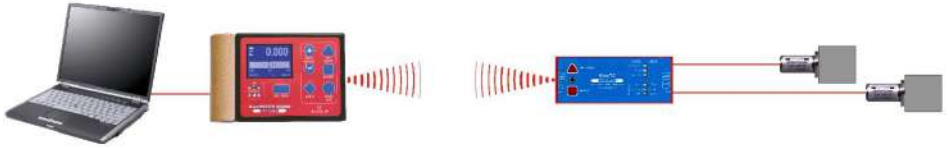

Configuration with wireless connection

## E5 OVERVIEW OF THE BLUETC

Panel with functional keys

- ON / MODE and
- ENTER

LED for instrument's status and menu selection

Aluminum housing anodized



Connectors for instruments/sensors/power supply

Connectors for output to PC/Laptop or external power supply

The BlueTC is supplied with or without **piggy-back mounted power supply**

## E5.1 FUNCTIONAL MENU WITH BLUE/TC / STRUCTURE

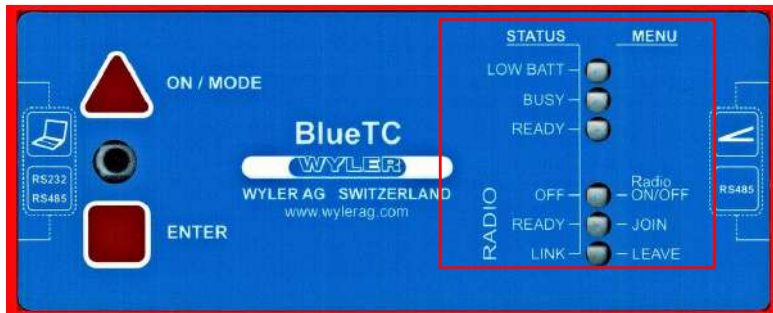

**MENU  
STRUCTURE  
USING THE KEY  
ON/MODE**

### REMARKS:

**A SPECIFIC PROCEDURE MUST BE PERFORMED BEFORE THE FOLLOWING FUNCTIONS ARE POSSIBLE**

By pressing the key <ON/MODE> several times the respective menu point may be selected. With <ENTER> the action will be confirmed.

|               |                                       |  |
|---------------|---------------------------------------|--|
| <b>MENÜ</b>   | <b>Relative ZERO<br/>LED red</b>      | deactivated  |
|               | <b>Absolute ZERO<br/>LED yellow</b>   | deactivated  |
|               | <b>Radio<br/>ON / OFF<br/>LED red</b> | Switch ON respectively OFF the radio module  |
|               | <b>JOIN GROUP<br/>LED green</b>       | Join a group   |
|               | <b>LEAVE<br/>LED blue</b>             | Leave a group  |
|               |                                       |  |
| <b>STATUS</b> | <b>LOW BATT<br/>LED red</b>           | In case of low battery power the LED glows red   |
|               | <b>BUSY<br/>LED yellow</b>            | Flashing yellow when instrument is busy  |
|               | <b>READY<br/>LED green</b>            | Flashing green when the instrument is ready  |
|               | <b>OFF<br/>LED red</b>                | Red when the radio is OFF  |
|               | <b>READY<br/>LED green</b>            | Flashing green when the radio is ON. The number of impulse corresponds to the number of instruments connected in the same group. |
|               | <b>LINK<br/>LED blue</b>              | Blue when the wireless data transmission is active   |

## E5.2 OPERATING THE BLUETC / SHORT DESCRIPTION OF THE VARIOUS KEYS



### <ON/MODE> - Key

#### Function - 1 –



Starting the **BlueTC**. Press the ON/MODE key until all the 6 LED's are illuminated, release key

- The LED „READY“ in **STATUS** is flashing rapidly
- The green LED „READY“ in **RADIO** is blinking so many times as instruments are connected in the radio mode (inclusive own address)
- In case instruments e.g. BlueLEVEL are already connected by radio the blue LED under **RADIO** is on

#### Deactivating the automatic instrument shut off of the BlueTC:

When pressing the **ON/MODE** key at the **starting of the instrument** longer than 10 seconds all LED's start blinking and the automatic shut off is deactivated. Normally (in battery mode) the instrument is automatically shut off after 60 minutes.

#### Exception:

When the BlueTC is connected to an external power supply the instrument never shuts off automatically.

#### Function - 2 -

The key **ON/MODE** is used for handling the internal **menu**.

Call for the menu functions

#### Attention

Wrong manipulation may cause severe changement of all the functions involved. It is strongly recommended that only authorized persons use the menu function. For general use of the T/C the menu must not be used.

Press the key <ENTER>. After 3 seconds press in addition the key <ON/MODE> for another 3 seconds. Then release both keys. The required menu point may now be selected by using the key <ON/MODE>. In case no key is activated during 10 seconds the menu function is pulled out.

#### Function - 3 -

For **shutting off** the BlueTC the key **ON/MODE** must be pressed continuously until all 6 LED's are on.



### <ENTER> – Key

#### Function – 1 –

Using the key <ENTER> together with the key <ON/MODE> is meant for confirming taken actions and for selection of menu functions

#### Function - 2 -

In connection with the software LEVELSOFT and MT-SOFT the key <ENTER> is used for collecting the actual measured value.

### E5.3 PIN-ASSIGNMENT OF THE BLUETC

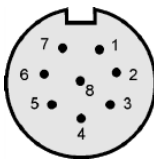

#### PIN-ASSIGNMENT PORT A<sub>1</sub> AND PORT A<sub>2</sub>

| Pin Number | Pin Name | Pin Type     | Pin Function          |
|------------|----------|--------------|-----------------------|
| 1          | VPP      | Input/Output | Unregulated Power     |
| 2          | VSS      | Input/Output | Ground                |
| 3          | VDD      | Input/Output | Regulated Power 5V DC |
| 4          | RTA      | Input/Output | RS485-Line A          |
| 5          | RTB      | Input/Output | RS485-Line B          |
| 6          | RA       | Input        | RS422-Line A          |
| 7          | RB       | Input        | RS422-Line B          |
| 8          | Taster   | Input        | -                     |

#### PIN-ASSIGNMENT PORT B<sub>1</sub> AND PORT B<sub>2</sub>

| Pin Number | Pin Name | Pin Type     | Pin Function          |
|------------|----------|--------------|-----------------------|
| 1          | VPP      | Input/Output | Unregulated Power     |
| 2          | VSS      | Input/Output | Ground                |
| 3          | VDD      | Input/Output | Regulated Power 5V DC |
| 4          | RTA      | Input/Output | RS485-Line A          |
| 5          | RTB      | Input/Output | RS485-Line B          |
| 6          | RA       | Input        | RS422-Line A          |
| 7          | RB       | Input        | RS422-Line B          |
| 8          | Taster   | Input        | -                     |

### E5.4 TECHNICAL DATA OF THE INTERFACE BLUETC

|   |   |
|---|---|
| Digital output / Digitalausgang                           | RS232 / RS422 / RS485, asynchron, 7 DataBits, 2 StopBits, no parity, 9600 bps |
| External power supply<br>Externe Stromversorgung          | BlueTC: + 5V DC, max. 450 mW (PIN 3) or/oder 8...28 V DC (PIN 1)              |
| Operating temperature range /<br>Betriebstemperatur       | 0 ... +40°C<br>-20 ... +70°C  |
| Storage temperature range /<br>Lagertemperatur            |   |
| Net weight without battery pack                           | 150g  |
| Net weight, incl. battery-pack and<br>incl. batteries     | 550g  |
| Netto-Gewicht ohne Batterie-Pack                          | 150g  |
| Netto-Gewicht, inkl. Batterie-Pack<br>und inkl. Batterien | 550g  |

## E5.5 DIMENSIONS OF BLUETC



BlueTC  
Top view



BlueTC  
Side view



BlueTC with battery pack  
Side view

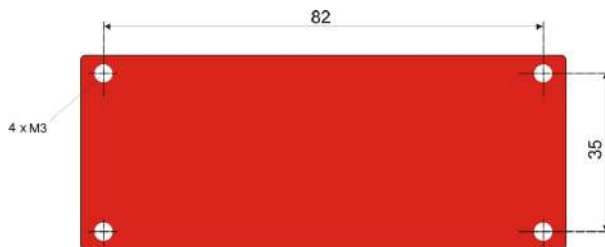

BlueTC  
Bottom view  
hole pattern

## F SENSOR STORAGE

When the sensors are not used they must be stored in a position that the sensor axes is horizontal with a  $\pm 5$  deg. range. This is required to avoid a possible long-time deformation of the pendulum Storage temperature should ideally be within 15 to 30 deg. C.

Normally any instruments requiring repair can be sent to the local WYLER partner (local distributor) who will take the necessary steps and make the arrangements for repair on behalf of the customer.

## G REPAIR-SERVICE

### EXPRESS REPAIR SERVICE, ERS

A large number of customers can not miss the instruments for a longer period as these are in daily operation. For these cases WYLER SWITZERLAND has created a new service called "Express Repair Service, ERS". Employing this service the transport time from the user to WYLER SWITZERLAND and back and thus the complete repair time can be reduced considerably.

A simplified description of this service:

- The customer announces the repair request to the local WYLER partner in his country.
- The WYLER partner will inform the customer about the possibility of the ERS service outlining the advantages and consequences of this service, such as e.g.
  - reduced total repair time
  - required acceptance to repair without quote up to 65 % of the price for a new instrument
  - suitable packing for air transport
  - expenses of the ERS
- In case the customer decides to use the ERS, the customer informs the local WYLER partner or directly WYLER SWITZERLAND providing the necessary data.
- The customer will receive all information and instructions necessary for a smooth handling, the customer has just to pack the product suitably and to fill in a form for the **TNT courier service** as well as to announce the readiness to the local TNT office for pick-up. Everything else will run automatically.
- Products reaching WYLER SWITZERLAND under this service will be handled with **first priority**, and the instrument will be returned using the same carrier.
- The invoicing will be through the WYLER partner in your country.

Please do not hesitate to make use of this service in order to have your WYLER instrument back at your disposal as soon as possible. In case of any questions please contact WYLER SWITZERLAND or your local distributor, we will gladly help you to use the ERS successfully.



WYLER SWITZERLAND is continuously enhancing their products and reserves the right to change technical specifications as well as the appearance without prior notice. For this reason the specifications and the pictures of the products delivered may be slightly different from those shown in the catalogue.

Die Firma WYLER AG ist stets um Produkteverbesserungen bemüht und behält sich das Recht vor, die technischen Daten und das äussere Erscheinungsbild jederzeit und ohne Vorankündigung zu ändern. Aus diesem Grund können die Spezifikationen und die Abbildungen der Produkte zum Teil leicht vom Katalog abweichen.



**WYLER**

**WYLER AG**  
**INCLINATION MEASURING SYSTEMS**  
**NEIGUNGSMESSSYSTEME**

Im Hölderli 13, CH-8405 WINTERTHUR (Switzerland)  
Tel. +41 (0) 52 233 66 66 Fax +41 (0) 52 233 20 53  
E-Mail: [wylers@wylersag.com](mailto:wylers@wylersag.com) Web: [www.wylersag.com](http://www.wylersag.com)

