

**WYLER**

# WYLER PRODUCTS AND SERVICES WYLER-PRODUKTE UND -SERVICES



**WYLER AG**  
Inclination measuring systems  
Neigungsmesssysteme

**Version 2025**  
Edition 1

Im Holderli 13, CH - 8405 Winterthur (Switzerland)  
+41 52 233 66 66  
wyler@wylerag.com  
www.wylerag.com



PRODUCT LINE

WYLERCLINO FRAME  
CLINOTRONIC S  
CLINOTRONIC PLUS

PRODUKTLINIE

**wylerCLINO Frame 10°**

Cast iron, prismatic measuring faces scraped



Guss, prismatische Messbasen geschabt

**wylerCLINO Frame 60°**

Cast iron



Guss

Aluminum



Aluminum

**Clinotronic S 45°**

Aluminum



Aluminium

**Clinotronic PLUS 45°/60°**

Aluminum



Aluminium

SPECIFICATIONS **CLINOTRONIC S** SPEZIFIKATIONEN



TECHNICAL SPECIFICATIONS	Clinotronic S	TECHNISCHE DATEN
Sensitivity	5 arcsec	Ziffernschrittwert
Measuring range	±45°	Messbereich
Limits of error within 12 months* (T <sub>A</sub> = 20°C) M <sub>w</sub> = measured value, T <sub>A</sub> = Ambient temperature	0.055% M <sub>w</sub> / min 15 arcsec	Fehlergrenze innerhalb von 12 Monaten* (T <sub>A</sub> = 20°C) M <sub>w</sub> = Messwert, T <sub>A</sub> = Umgebungstemperatur
Response time	< 5 sec	Einstelldauer
Digital output	Bluetooth Low Energy	Digitalausgang
Power supply :		Stromversorgung
<ul style="list-style-type: none"> <li>Lithium-ion battery</li> <li>External power</li> </ul>	1 x 3.6 V, 3333 mAh, (12 Wh) 5 V (USB-C)	<ul style="list-style-type: none"> <li>Lithium-Ionen-Batterie</li> <li>Externe Stromversorgung</li> </ul>
Battery life with medium brightness of LCD screen and Bluetooth® on.	max 33 h	Betriebsdauer bei mittlerer Bildschirm-Helligkeit und Bluetooth® aktiviert.
Max current consumption during charging process at max brightness of LCD screen and Bluetooth® activated.	500 mA, 5 V	Max. Stromverbrauch während des Ladeprozesses bei max. Bildschirm-Helligkeit und Bluetooth® aktiviert.
Operating temperature	0 ... 40°C	Betriebstemperatur
Storage temperature		Lagertemperatur
including lithium-ion battery with recoverable capacity 80% < one month < three months < one year	-20 ... 50°C -20 ... 40°C -20 ... 20°C	inklusive Lithium-Ionen-Batterie mit verwertbarer Kapazität 80% < ein Monat < drei Monate < ein Jahr
Protection class (with protection cap for USB-C)	IP 64	Schutzklasse (mit Schutzkappe für USB-C)
Net weight, including lithium-ion battery Housing aluminum hard anodized	400 g	Netto-Gewicht, inklusive Lithium-Ionen-Batterie Aluminiumgehäuse harteloxiert
Length	100 mm	Länge
Width	30 mm	Breite
Height	75 mm	Höhe
CE conformity Meets emission and immunity requirements		CE-Konformität Erfüllt die Standards für Emission und Störfestigkeit

\*typical value

\*typischer Wert



## SPECIFICATIONS

## CLINOTRONIC S

## SPEZIFIKATIONEN



Units	Decimals Dezimalstellen	Formats of value in display Darstellungsformate des Wertes in der Anzeige	Unit in display Einheit in Anzeige	Einheiten
<b>Clinotronic S</b>				
degree + arc minutes + arc seconds		xx°xx'xx"	DEG ° ' "	Grad + Bogenminuten + Bogensekunden
degree	3		DEG °	Grad
mm per m	2	xxxx.xx	mm/m	mm pro m
Inch per 10 inch	4	xx.xxxx	"/10"	Zoll pro 10 Zoll
Inch per 12 inch	4	xx.xxxx	"/12"	Zoll pro 12 Zoll
milli radian	2	xxxx.xx	mRad	Milli-Radian
per cent	3	xxx.xxx	Percent %	Prozent
per mill	2	xxxx.xx	per mille	Promille
centesimal degree	3	xxx.xxx	Gon	Neugrad
artillery per mill		xxxx.xx	Artillery Promille	Artillerie Promille
mm per relative base	2	xxxx.xx	mm/1435mm	mm pro relative Basis
Inch per relative base	4	xx.xxxx	"/10.00"	Zoll pro relative Basis
slope	1...4	1/xxxxx	Slope 1/xxx	Gefälle

SPECIFICATIONS CLINOTRONIC S SPEZIFIKATIONEN

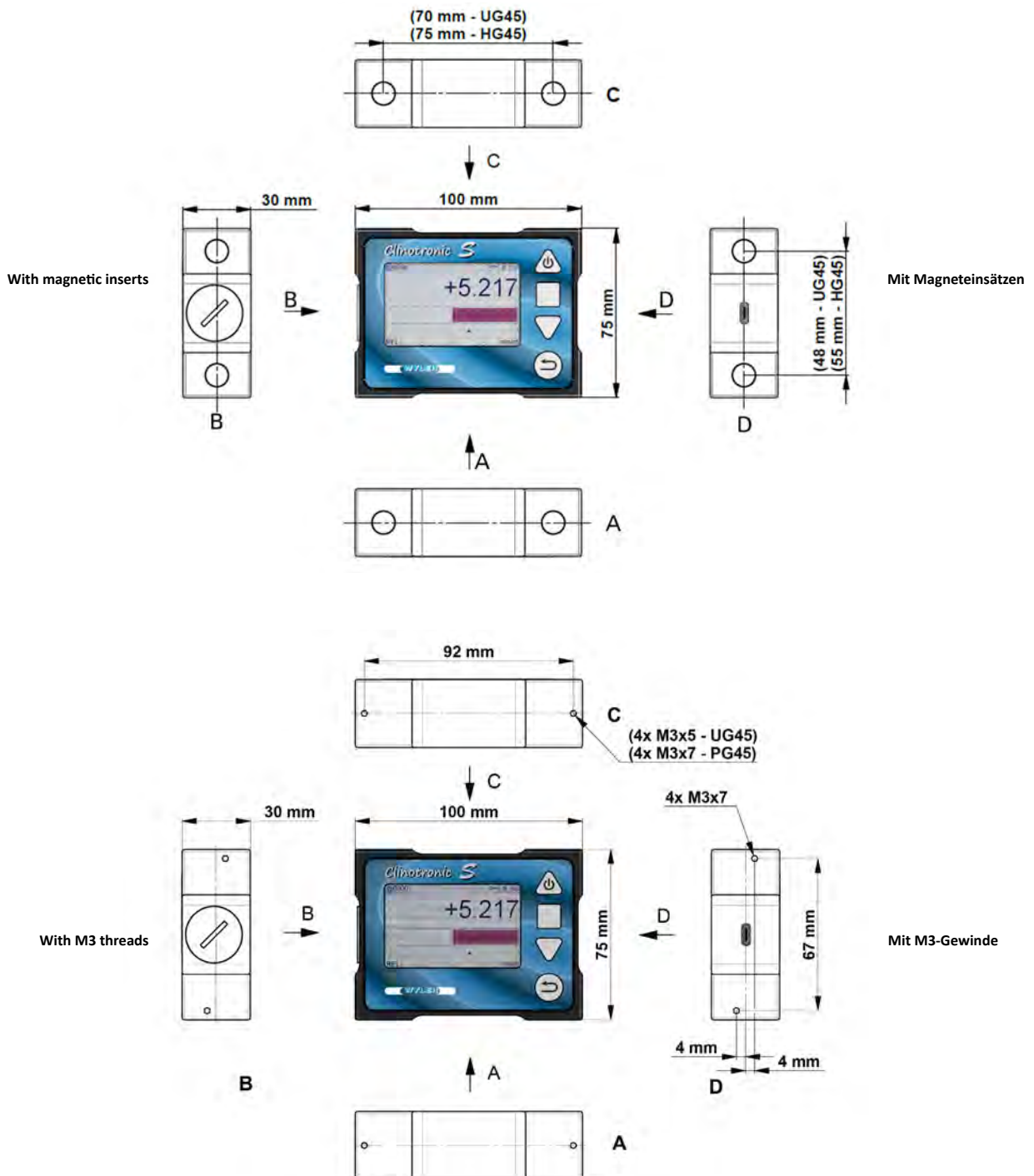



**TYPES** **CLINOTRONIC S BUNDLE** **TYPEN**



Clinotronic S Bundle									
Magnetic inserts Magneteinsätze				P/N Produktnummer	Threads M3 Gewinde M3				
Bottom Unten	Left Links	Top Oben	Right Rechts	± 45°	Bottom Unten	Left Links	Top Oben	Right Rechts	
				015-S-XG45					
X	X	X	X	015-S-HG45					
				015-S-PG45	X	X	X	X	
X	X	X	X	015-S-UG45	X	X	X	X	









Scope of delivery	Lieferumfang
<ul style="list-style-type: none"> <li>Clinotronic S, including 1 lithium-ion battery</li> <li>USB power adapter (100 V ... 240 V)</li> <li>USB-C cable 1.4 m</li> <li>Quick reference</li> <li>Manual download available at <a href="http://www.wylerag.com">www.wylerag.com</a></li> <li>Case for Clinotronic S</li> </ul>	<ul style="list-style-type: none"> <li>Clinotronic S, inklusive 1 Lithium-Ionen-Batterie                             <ul style="list-style-type: none"> <li>USB-Netzteil (100 V ... 240 V)</li> <li>USB-C-Kabel 1.4 m</li> <li>Quickreferenz</li> </ul> </li> <li>Bedienungsanleitung downloadbar unter <a href="http://www.wylerag.com">www.wylerag.com</a> <ul style="list-style-type: none"> <li>Koffer für Clinotronic S</li> </ul> </li> </ul>



**TYPES** **CLINOTRONIC S MODULAR** **TYPEN**

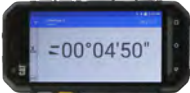

Clinotronic S Modular									
Magnetic inserts Magneteinsätze				P/N Produktnummer	Threads M3 Gewinde M3				
Bottom Unten	Left Links	Top Oben	Right Rechts	± 45°	Bottom Unten	Left Links	Top Oben	Right Rechts	
				015-SM-XG45					
X	X	X	X	015-SM-HG45					
				015-SM-PG45	X	X	X	X	
X	X	X	X	015-SM-UG45	X	X	X	X	

Scope of delivery	Lieferumfang
<ul style="list-style-type: none"> <li>Clinotronic S, including 1 lithium-ion battery</li> <li>Manual per download from <a href="http://www.wylerag.com">www.wylerag.com</a></li> </ul> <p>=&gt; separate order for case required</p>	<ul style="list-style-type: none"> <li>Clinotronic S, inklusive 1 Lithium-Ionen-Batterie</li> <li>Bedienungsanleitung per Download von <a href="http://www.wylerag.com">www.wylerag.com</a></li> </ul> <p>=&gt; separate Bestellung für Koffer nötig</p>

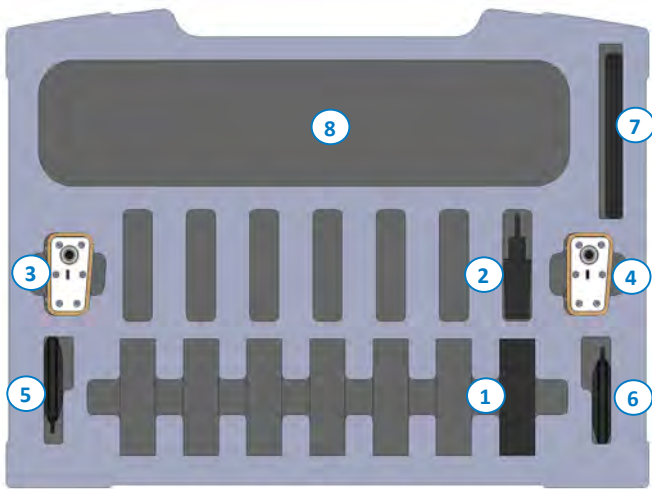
CASE - XL	CLINOTRONIC S MODULAR		KOFFER - XL
Location Ort	Space for ... Platz für ...	... or ... oder	
1	7 x 	7 x 	
2	7 x 		
3			
4			
5			
6			
7			
8	7 x 		

Scope of delivery	P/N Produktnummer	Lieferumfang
	422-022B0020	

**CASE - M** **CLINOTRONIC S MODULAR** **KOFFER - M**

Location Ort	Space for ... Platz für ...	... or ... oder
1		
2		
3		
4		
5		
6		
7		
8		
9		
10		
11		

**Scope of delivery** **P/N** **Produktnummer** **Lieferumfang**



Case M with inlay for 2 Clinotronic S

422-024B0011

Koffer M mit Einlage für 2 Clinotronic S



CASE - S      CLINOTRONIC S MODULAR      KOFFER - S

Location Ort	Space for ... Platz für ...	... or ... oder	... or ... oder
1			
2			
3			
4			

Scope of delivery      P/N  
Produktnummer      Lieferumfang











Case M with inlay for 1 Clinotronic S

422-015-0006

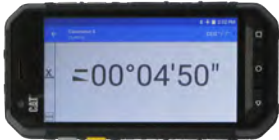
Koffer M mit Einlage für 1 Clinotronic S

**ACCESSORIES** **CLINOTRONIC S MODULAR** **ZUBEHÖR**



		P/N Produktnummer	
Lithium-ion battery A replacement battery can only be ordered in combination with a Clinotronic S in the same case.		015-S-B2600	Lithium-Ionen-Batterie Eine Ersatzbatterie kann nur in Kombination mit einem Clinotronic S im selben Koffer bestellt werden.
External charger (100 V ... 240 V) for 2 lithium-ion batteries		015-S-Charge	Externes Ladegerät (100 V ... 240 V) für 2 Lithium-Ionen-Batterien
USB power adapter (100 V ... 240 V) to charge the lithium-ion battery in the Clinotronic S		015-003-002	USB Netzteil (100 V ... 240 V) um die Lithium-Ionen-Batterie im Clinotronic S zu laden
USB-C cable 1.4 m		015-014-001	USB-C-Kabel 1.4 m
Outdoor android based remote display with pre-installed APP wylerUNIVERSAL		016-006-001	Outdoor Android basierte externe Anzeige mit vorinstallierter APP wylerUNIVERSAL
wylerTRIGGER		015-005-007	wylerTRIGGER
Software wylerCHART		029-CHART-L1	Software wylerCHART
Software wylerINSERT		029-INSERT-L1	Software wylerINSERT
wylerCONNECT		029-0001-003	wylerCONNECT
wylerCONNECT MINI Bluetooth USB-communication module		015-006-001	wylerCONNECT MINI Bluetooth USB-Kommunikationsmodul

Calibration certificate	P/N		Produktnummer	Kalibrierzertifikat
SCS calibration certificate for 1 Clinotronic S			SCS CLINOTRONIC	SCS-Kalibrierzertifikat für 1 Clinotronic S

ACCESSORIES CLINOTRONIC S ZUBEHÖR



The wylerMASTER is designed exclusively to calibrate inclination devices of the typ Clinotronic S and Clinotronic PLUS with a measuring range of 45 °.

Der wylerMASTER ist ausschliesslich bestimmt für das Kalibrieren von Neigungsmessgeräten vom Typ Clinotronic S und Clinotronic PLUS mit einem Messbereich von ±45°.

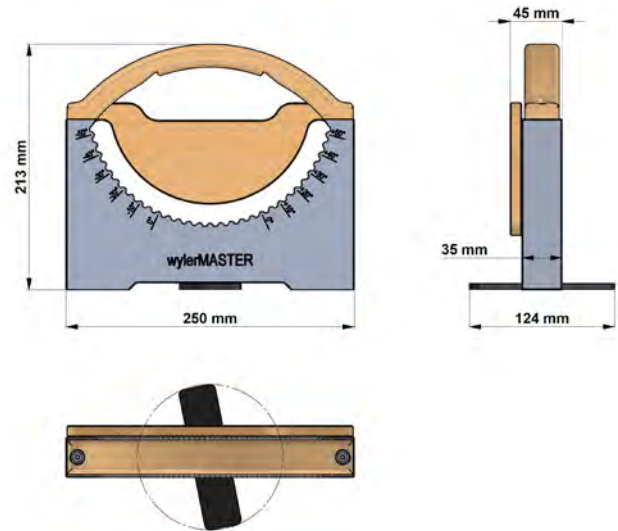

Technical data	wylerMASTER			Technische Daten
Range of calibration	±50°			Kalibrierbereich
Steps of calibration	5°			Kalibrierung in Schritten
Geometric precision	0 ... 10° 5 arcsec	15 ... 25° 10 arcsec	30 ... 50° 15 arcsec	Geometrie-Genauigkeit
Operation temperature	18 ... 23 °C			Betriebstemperatur
Storage temperature	-30 ... 70 °C			Lagertemperatur
Weight net	6.2 kg			Gewicht netto
Weight scope of delivery	7.8 kg			Gewicht Lieferumfang
Dimension L x W x H	250 x 45 x 213 mm			Abmessungen L x B x H
Dimension L x W x H / support extended	250 x 124 x 213 mm			Abmessungen L x B x H / Stützen ausgefahren

Material	Material
<ul style="list-style-type: none"> <li>Body: stainless steel, hardened 55 HRC</li> <li>Handle and back plate: steamed, varnished wood</li> <li>Support: POM</li> </ul>	<ul style="list-style-type: none"> <li>Körper: Stahl rostfrei, gehärtet 55 HRC</li> <li>Griff und Rückplatte: Schicht-Holz gedämpft, lackiert</li> <li>Stütze: POM</li> </ul>

Scope of delivery	P/N Produktnummer	Lieferumfang
<ul style="list-style-type: none"> <li>wylerMASTER</li> <li>Quick Reference</li> <li>SCS certificate</li> <li>Case for storage, transport and shipping 390 x 310 x 147 mm</li> </ul>	200-015-0001	<ul style="list-style-type: none"> <li>wylerMASTER</li> <li>Quick Referenz</li> <li>SCS-Zertifikat</li> <li>Gerätekofter für Lagerung, Transport und Versand 390 x 310 x 147 mm</li> </ul>

Calibration certificate	P/N	Produktnummer	Kalibrierzertifikat
SCS calibration certificate for wylerMASTER		SCS MASTER	SCS-Kalibrierzertifikat für wylerMASTER

SPECIFICATIONS **CLINOTRONIC PLUS** SPEZIFIKATIONEN



TECHNICAL SPECIFICATIONS	Clinotronic PLUS				TECHNISCHE SPEZIFIKATIONEN
Sensitivity	5 arcsec				Zifferschrittwert
Measuring range	±45°		±60°		Messbereich
Within the range of ...	0 ... 10°	10 ... 30°	30 ... 45°	45 ... 60°	Im Bereich von ...
Limits of error within 12 months* (T <sub>A</sub> = 20°C) T <sub>A</sub> = Ambient temperature	≤1 arcmin + 1 digit	≤1.5 arcmin + 1 digit	≤2 arcmin + 1 digit	≤3 arcmin + 1 digit	Fehlergrenze innerhalb von 12 Monaten* (T <sub>A</sub> = 20°C) T <sub>A</sub> = Umgebungstemperatur
Response time	< 5 sec				Einstelldauer
Digital output	RS485, asynchronous, 7 DataBits, 2 StopBits, no parity, 9600 bps				Digitalausgang
Batterie - Size AA Optional (rechargeable)	1 x 1.5 V Alkaline 1 x 1.2 V NiMH				Batterie - Grösse AA Optional (wiederaufladbar)
Operating temperature	0 ... 40 °C				Betriebstemperatur
Storage temperature	- 30 ... 70 °C				Lagertemperatur
Net weight, including batteries Housing aluminum hard anodized	400 g				Netto-Gewicht, inklusive Batterien Aluminiumgehäuse harteloxiert
Length	100 mm				Länge
Width	30 mm				Breite
Height	75 mm				Höhe
CE conformity Meets emission and immunity requirements					CE-Konformität Erfüllt die Standards für Emission und Störfestigkeit

\*typical value

\*typischer Wert

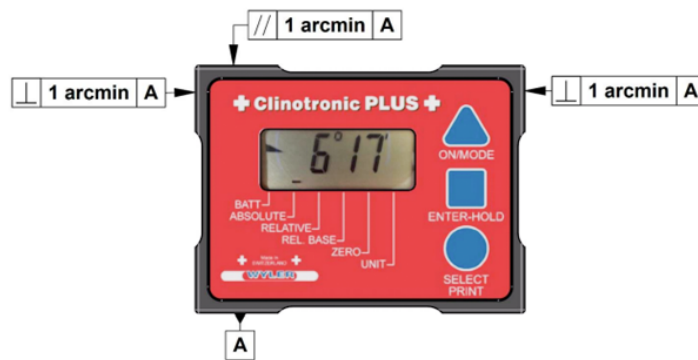

Clinotronic PLUS				
Units	Decimals Dezimalstellen	Value in Display Wert in der Anzeige	Unit in Display Einheit in der Anzeige	Einheiten
mm per m	2	xx.xx	mm/m	mm pro m
Inch per 10 Inch	4	.xxxx	"/10"	Zoll pro 10 Zoll
Inch per 12 Inch	4	.xxxx	"/12"	Zoll pro 12 Zoll
milli radian	2	xx.xx	mRad	Milli-Radian
milli radian	0	.xxxx	mRad	Milli-Radian
degree	2	xx.xx°	DEG	Grad
degree	4	.xxxx°	DEG	Grad
degree + arc minutes		xx'xx'	DEG	Grad + Bogenminuten
arc minutes + arc seconds		xx'xx"	DEG	Bogenminuten + Bogensekunden
centesimal degree	2	xx.xx	GON	Neugrad
centesimal degree	4	.xxxx	GON	Neugrad
mm per relative base	2	xx.xx	mm/m *)	mm pro relative Basis
mm per relative base	4	.xxxx	mm/m *)	mm pro relative Basis
Inch per relative base	4	.xxxx	"/10" *)	Zoll pro relative Basis
artillery per mill	0	xxxx		Artillerie Promille

\*) Cursor at the position „REL.BASE“

\*) Cursor bei der Position „REL.BASE“

SPECIFICATIONS **CLINOTRONIC PLUS** SPEZIFIKATIONEN



With magnetic inserts

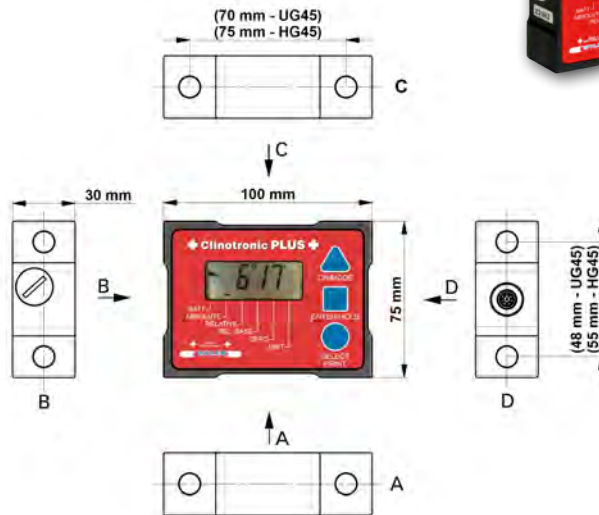

Mit Magneteinsätzen

With threaded holes M3

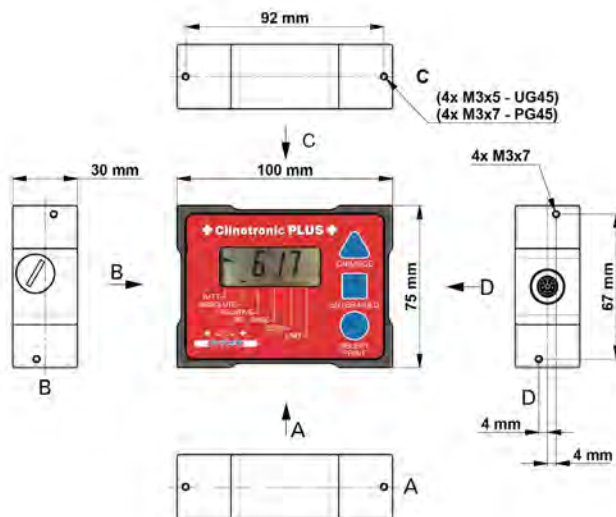

Mit Gewinde M3

TYPES **CLINOTRONIC PLUS** TYPEN

Clinotronic PLUS									
Magnetic inserts Magneteinsätze				P/N Produktnummer	P/N Produktnummer	Threads M3 Gewinde M3			
Bottom Unten	Left Links	Top Oben	Right Rechts	± 45°	± 60°	Bottom Unten	Left Links	Top Oben	Right Rechts
				015-PLUS-XG45	015-PLUS-XG60				
X	X	X	X	015-PLUS-HG45	015-PLUS-HG60				
				015-PLUS-PG45	015-PLUS-PG60	X	X	X	X
X	X	X	X	015-PLUS-UG45	015-PLUS-UG60	X	X	X	X

Scope of delivery	Lieferumfang
<ul style="list-style-type: none"> <li>1 Clinotronic PLUS</li> <li>1 Battery 1.5V, size AA</li> <li>1 Manual</li> <li>1 Storage case</li> </ul>	<ul style="list-style-type: none"> <li>1 Clinotronic PLUS</li> <li>1 Batterie 1.5V, Grösse AA</li> <li>1 Bedienungsanleitung</li> <li>1 Gerätekofter</li> </ul>

Calibration certificate	P/N	Produktnummer	Kalibrierzertifikat
SCS calibration certificate for 1 Clinotronic PLUS		SCS CLINOTRONIC	SCS-Kalibrierzertifikat für 1 Clinotronic PLUS



**ACCESSORIES** **CLINOTRONIC PLUS** **ZUBEHÖR**



Batteries	DETAILS	P/N Produktnummer	Batterien
Battery – size AA (single)	1.5 V Alkaline	<b>604-012-0001</b>	Batterie – Grösse AA (einzeln)
Battery for Clinotronic (predecessor of Clinotronic PLUS)	3.6 V	<b>604-015-0001</b>	Batterie für Clinotronic (Vorgängermodell von Clinotronic PLUS)

Cable and adapters connecting Clinotronic PLUS to PC	P/N Produktnummer	Kabel und Adapter zur Verbindung von Clinotronic PLUS an PC
RS232 cable 2.5 m	<b>015-025-928-232</b>	RS232 Kabel 2.5 m
USB cable 1.8 m (only in combination with the software LabEXCEL CLINO)	<b>015-018-468-USB</b>	USB Kabel 1.8 m (nur in Kombination mit der Software LabEXCEL CLINO)
Adapter RS232 / USB	<b>024-232-USB</b>	Adapter RS232 / USB
Adapter RS485 / RS232	<b>065-STECKER-232</b>	Adapter RS485 / RS232

Various	P/N Produktnummer	Verschiedenes
Remote button (key) cable, 2.5 m	<b>015-025-8D1PLUS</b>	Auslösetaster mit Kabel, 2.5 m
wylerTRIGGER	<b>015-005-007</b>	wylerTRIGGER



Technical data	clinoMASTER	Technische Daten
Range of calibration	± 50°	Kalibrierbereich
21 steps of calibration	21 x 5°	21 Kalibrierschritte
Geometric precision	30 arcsec	Geometrie-Genauigkeit
Operation temperature	18 ... 23 °C	Betriebstemperatur
Storage temperature	-30 ... 70 °C	Lagertemperatur
Weight	8.4 kg	Gewicht
Length x Width x Height	250 x 62 x 150 mm	Länge x Breite x Höhe
Material		Material
Cast iron, surface chromium-plated		Grauguss, Flächen verchromt

Scope of delivery	P/N Produktnummer	Lieferumfang
<ul style="list-style-type: none"> <li>clinoMASTER</li> <li>SCS certificate</li> <li>Case for storage and transport</li> </ul>	<b>015-000-021</b>	<ul style="list-style-type: none"> <li>clinoMASTER</li> <li>SCS-Zertifikat</li> <li>Gerätekoffer für Lagerung und Transport</li> </ul>

Calibration certificate	P/N	Produktnummer	Kalibrierzertifikat
SCS calibration certificate for CLINOMASTER		<b>SCS MASTER</b>	SCS-Kalibrierzertifikat für CLINOMASTER



*Quality*

*Service + Partnership*

*Innovation + Competence*

*Qualität*

*Service + Partnerschaft*

*Innovation + Kompetenz*



The WYLER AG is continuously enhancing their products and reserves the right to change technical specifications as well as the appearance without prior notice. For this reason the specifications and the pictures of the products delivered may be slightly different from those shown in the catalogue.

Die WYLER AG ist stets um Produkteverbesserungen bemüht und behält sich das Recht vor, die technischen Daten und das äussere Erscheinungsbild jederzeit und ohne Vorankündigung zu ändern. Aus diesem Grund können die Spezifikationen und die Abbildungen der Produkte zum Teil leicht vom Katalog abweichen.