

WYLER

INCLINATION MEASURING SYSTEMS

PRODUCTS AND SERVICES

2026

Edition 2



PRODUKTE UND SERVICES

NEIGUNGSMESSSYSTEME

www.wylerag.com

wylerCLINO Frame, Clinotronic S, Clinotronic PLUS



Produkt line

wylerCLINO Frame, Clinotronic S
and Clinotronic PLUS

Produktlinie

The wylerCLINO Frame and Clinotronic product line combine the need of large measuring ranges and highest accuracy.

- wylerCLINO Frame with measuring range $\pm 10^\circ$ in cast iron, prismatic measuring bases scraped
- Clinotronic S with measuring range $\pm 45^\circ$ in aluminum
- wylerCLINO Frame with measuring range $\pm 60^\circ$ in cast iron or aluminum, measuring faces grinded
- Clinotronic PLUS with measuring range $\pm 45^\circ / \pm 60^\circ$ in aluminum

wylerCLINO Frame and Clinotronic S

- are equipped with radio data transmission
- have a large and very easy-to-read color display
- can indicate all current units
- have internal software to perform simple zero setting with a reversal measurement
- can be adjusted to local gravity
- fulfils the strict CE requirements (immunity against electromagnetic smog)

wylerCLINO Frame

- offer various display methods such as bar graphs or spirit levels
- rugged housing, with prismatic bases made of either aluminum hard anodized or cast iron, nickel plated
- built-in cross vial for easy alignment of the vertical axis avoiding "lateral stability errors"
- powered by standard 1.5 V batteries, rechargeable batteries or with mains adapter
- magnetic inserts optional
- versions with range $\pm 60^\circ$ can be recalibrated with the help of internal software in combination with simple calibration tools that are supplied together with the instrument

Clinotronic S

- Lithium-ion battery
- Magnetic inserts optional
- Threaded holes optional

Clinotronic PLUS

- Simple LCD display
- Powered by standard 1.5 V batteries
- Magnetic inserts optional
- Threaded holes optional

Die wylerCLINO Frame und Clinotronic Produktlinien kombinieren grosse Messbereiche mit der höchsten Genauigkeit.

- wylerCLINO Frame mit Messbereich $\pm 10^\circ$ in Guss, prismatische Basen geschabt
- Clinotronic S mit Messbereich $\pm 45^\circ$ in Aluminium
- wylerCLINO Frame mit Messbereich $\pm 60^\circ$ in Guss oder Aluminium, Messbasen geschliffen
- Clinotronic PLUS mit Messbereich $\pm 45^\circ / \pm 60^\circ$ in Aluminium

wylerCLINO Frame und Clinotronic S

- sind mit Funk-Datenübertragung ausgestattet
- haben eine grosse, gut ablesbare farbige Digitalanzeige
- können alle gängigen Masseinheiten anzeigen
- haben eine interne Software, um mittels Umschlagmessung eine Nullpunktkorrektur vorzunehmen
- können an die lokale Gravitation angepasst werden
- erfüllen die strengen CE-Normen (Immunität gegenüber elektromagnetischen Einflüssen)

wylerCLINO Frame

- bieten verschiedene Anzeige-Methoden, wie Balken-Grafiken oder Libellen-Richtwaagen
- robuste Gehäuse, mit prismatischen Basen aus Aluminium harteloxiert oder Grauguss vernickelt
- eingebaute Libelle zum Ausrichten der vertikalen Nebenachse zur Vermeidung von "Quer-Stabilitätsfehlern"
- Betrieb mit handelsüblichen 1.5 V Batterien, Akkus oder mit Steckernetzteil
- Magneteinsätze optional
- Versionen mit Messbereich $\pm 60^\circ$ können mithilfe der internen Software im Zusammenspiel mit geeigneten Kalibrierstiften neu kalibriert werden

Clinotronic S

- Lithium-Ionen-Batterie
- Magneteinsätze optional
- Gewindeeinsätze optional

Clinotronic PLUS

- Einfache LCD-Anzeige
- Betrieb mit handelsüblicher 1.5 V Batterie
- Magneteinsätze optional
- Gewindeeinsätze optional

Specifications

Clinotronic S

Spezifikationen



Specifications	Clinotronic S	Spezifikationen
Sensitivity	5 arcsec	Zifferschrittwert
Measuring range	±45°	Messbereich
Limits of error within 12 months* (T _A = 20°C)	0.055 % M _w / min. 15 arcsec	Fehlergrenze innerhalb von 12 Monaten* (T _A = 20°C)
M _w = measured value, T _A = Ambient temperature		M _w = Messwert, T _A = Umgebungstemperatur
Response time	< 5 sec	Einstelldauer
Digital output	Bluetooth Low Energy	Digitalausgang
Power supply :		Stromversorgung
<ul style="list-style-type: none"> Lithium-ion battery External power 	1 x 3.6 V, 3333 mAh, (12 Wh) 5 V (USB-C)	<ul style="list-style-type: none"> Lithium-Ionen-Batterie Externe Stromversorgung
Battery life with medium brightness of LCD screen and Bluetooth® on.	max 33 h	Betriebsdauer bei mittlerer Bildschirm-Helligkeit und Bluetooth® aktiviert.
Max. current consumption during charging process at max. brightness of LCD screen and Bluetooth® activated	500 mA, 5 V	Max. Stromverbrauch während des Ladeprozesses bei max. Bildschirm-Helligkeit und Bluetooth® aktiviert.
Operating temperature	0 ... 40°C	Betriebstemperatur
Storage temperature		Lagertemperatur
including lithium-ion battery with recoverable capacity 80 %		inklusive Lithium-Ionen-Batterie mit verwertbarer Kapazität 80 %
< one month < three months < one year	-20 ... 50°C -20 ... 40°C -20 ... 20°C	< ein Monat < drei Monate < ein Jahr
Protection class (with protection cap for USB-C)	IP 64	Schutzklasse (mit Schutzkappe für USB-C)
Net weight, including lithium-ion battery Housing aluminum hard anodized	400 g	Netto-Gewicht, inklusive Lithium-Ionen-Batterie Aluminiumgehäuse harteloxiert
Length	100 mm	Länge
Width	30 mm	Breite
Height	75 mm	Höhe
CE conformity Meets emission and immunity requirements		CE-Konformität Erfüllt die Standards für Emission und Störfestigkeit

*typical value

*typischer Wert



Specifications

Clinotronic S

Spezifikationen



Units	Decimals Dezimalstellen	Formats of value in display Darstellungsformate des Wertes in der Anzeige	Unit in display Einheit in Anzeige	Einheiten
Clinotronic S				
degree + arc minutes + arc seconds		xx°xx'xx"	DEG ° ' "	Grad + Bogenminuten + Bogensekunden
degree	3	xx.xxx	DEG °	Grad
mm per m	2	xxxx.xx	mm/m	mm pro m
Inch per 10 inch	4	xx.xxxx	"/10"	Zoll pro 10 Zoll
Inch per 12 inch	4	xx.xxxx	"/12"	Zoll pro 12 Zoll
milli radian	2	xxxx.xx	mRad	Milli-Radian
per cent	3	xxx.xxx	Percent %	Prozent
per mill	2	xxxx.xx	per mille	Promille
centesimal degree	3	xxx.xxx	Gon	Neugrad
artillery per mill		xxxx.xx	Artillery Promille	Artillerie Promille
mm per relative base	2	xxxx.xx	mm/1435mm	mm pro relative Basis
Inch per relative base	4	xx.xxxx	"/10.00"	Zoll pro relative Basis
slope	1...4	1/xxxxx	Slope 1/xxx	Gefälle

Specifications

Clinotronic S

Spezifikationen

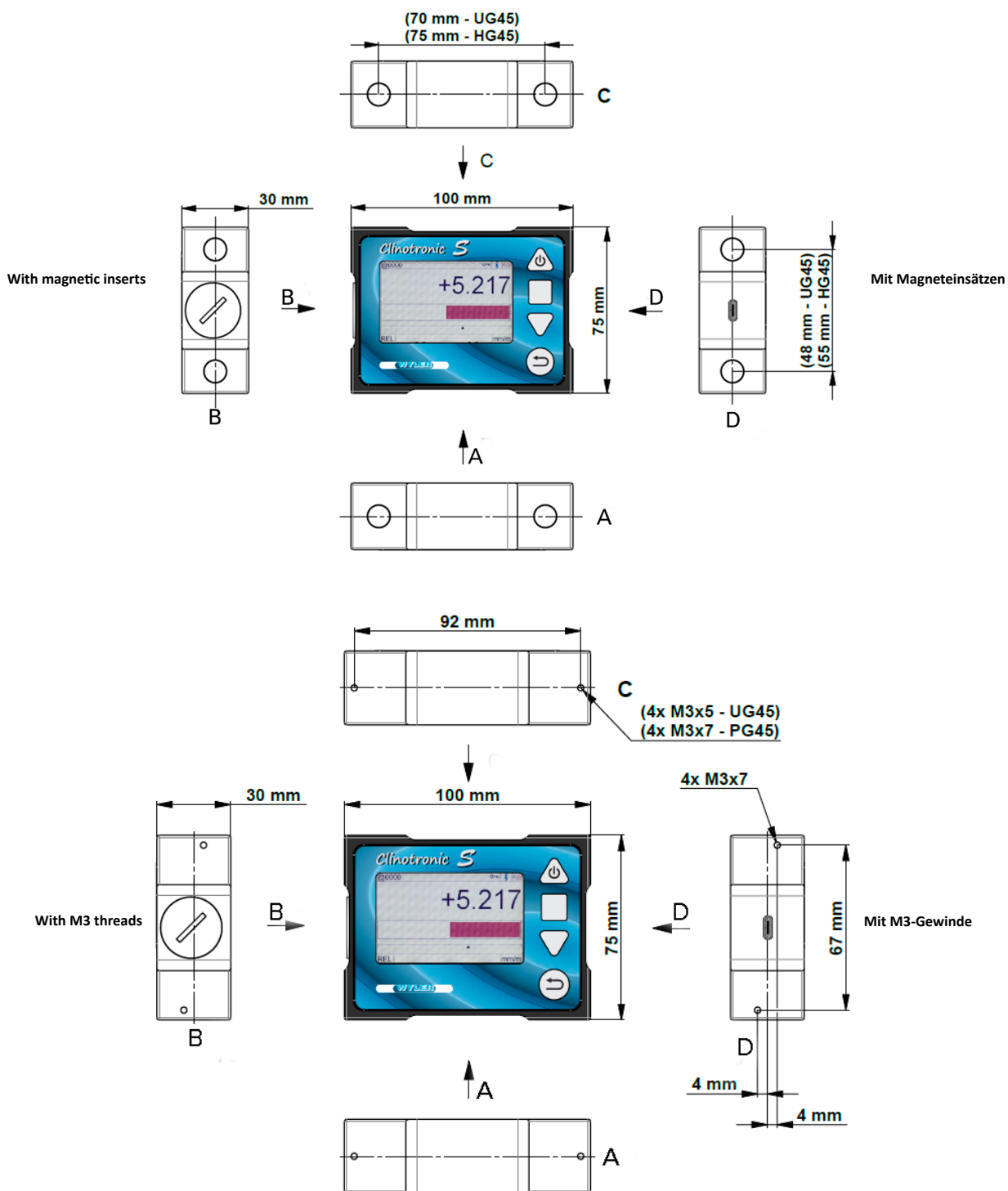

Types

Clinotronic S Bundle

Typen



Clinotronic S Bundle									
Magnetic inserts Magneteinsätze				P/N Produktnummer	Threads M3 Gewinde M3				
Bottom Unten	Left Links	Top Oben	Right Rechts	±45°	Bottom Unten	Left Links	Top Oben	Right Rechts	
				015-S-XG45					
X	X	X	X	015-S-HG45					
				015-S-PG45	X	X	X	X	
X	X	X	X	015-S-UG45	X	X	X	X	

Scope of delivery	Lieferumfang
<ul style="list-style-type: none"> Clinotronic S, including 1 lithium-ion battery USB power adapter (100 V ... 240 V) USB-C cable 1.4 m Quick reference Manual download available at www.wylerag.com Case for Clinotronic S 	<ul style="list-style-type: none"> Clinotronic S, inklusive 1 Lithium-Ionen-Batterie USB-Netzteil (100 V ... 240 V) USB-C-Kabel 1.4 m Kurzanleitung Bedienungsanleitung downloadbar unter www.wylerag.com Koffer für Clinotronic S

Types

Clinotronic S Modular

Typen



Clinotronic S Modular									
Magnetic inserts Magneteinsätze				P/N Produktnummer	Threads M3 Gewinde M3				
Bottom Unten	Left Links	Top Oben	Right Rechts	± 45°	Bottom Unten	Left Links	Top Oben	Right Rechts	
				015-SM-XG45					
X	X	X	X	015-SM-HG45					
				015-SM-PG45	X	X	X	X	
X	X	X	X	015-SM-UG45	X	X	X	X	

Scope of delivery	Lieferumfang
<ul style="list-style-type: none"> Clinotronic S, including 1 lithium-ion battery Manual per download from www.wylerag.com <p>=> separate order for case required</p>	<ul style="list-style-type: none"> Clinotronic S, inklusive 1 Lithium-Ionen-Batterie Bedienungsanleitung per Download von www.wylerag.com <p>=> separate Bestellung für Koffer nötig</p>

Case XL

Clinotronic S Modular

Koffer XL











Location Ort	Space for ... Platz für or ... oder
1	7 x 	7 x 
2	7 x 	
3		
4		
5		
6		
7		
8	7 x 	

Scope of delivery	P/N Produktnummer	Lieferumfang
	422-022B0020	

Case M

Clinotronic S Modular

Koffer M

Location Ort	Space for ... Platz für Or ... oder
1		
2		
3		
4		
5		
6		
7		
8		
9		



Scope of delivery	P/N Produktnummer	Lieferumfang
	422-024B0011	
Case M with inlay for 2 Clinotronic S		Koffer M mit Einlage für 2 Clinotronic S

Case S

Clinotronic S Modular

Koffer S

	Space for ... Platz für or ... oder	... or ... oder
1			
2			
3			









Scope of delivery	P/N Produktnummer	Lieferumfang
	422-015-0006	
Case S with inlay for 1 Clinotronic S		Koffer S mit Einlage für 1 Clinotronic S

Accessories

Clinotronic S Modular

Zubehör



	P/N Produktnummer	
<p>Lithium-ion battery A replacement battery can only be ordered in combination with a Clinotronic S in the same case.</p> 	015-S-B2600	Lithium-Ionen-Batterie Eine Ersatzbatterie kann nur in Kombination mit einem Clinotronic S im selben Koffer bestellt werden.
<p>External charger (100 V ... 240 V) for 2 lithium-ion batteries</p> 	015-S-Charge	Externes Ladegerät (100 V ... 240 V) für 2 Lithium-Ionen-Batterien
<p>USB power adapter (100 V ... 240 V) to charge the lithium-ion battery in the Clinotronic S</p> 	015-003-002	USB Netzteil (100 V ... 240 V) um die Lithium-Ionen-Batterie im Clinotronic S zu laden
<p>USB-C cable 1.4 m</p> 	015-014-001	USB-C-Kabel 1.4 m
<p>Outdoor Android-based remote display with pre-installed APP wylerUNIVERSAL</p> 	004-03-00-D	Outdoor Android basierte externe Anzeige mit vorinstallierter APP wylerUNIVERSAL
<p>wylerTRIGGER</p> 	015-005-007	wylerTRIGGER
<p>Software wylerCHART</p> 	029-CHART-L1	Software wylerCHART
<p>Software wylerINSERT</p> 	029-INSERT-L1	Software wylerINSERT
<p>wylerCONNECT</p> 	029-0001-003	wylerCONNECT

Calibration certificate	P/N		Produktnummer	Kalibrierzertifikat
SCS calibration certificate for 1 Clinotronic S			SCS CLINOTRONIC	SCS-Kalibrierzertifikat für 1 Clinotronic S

Accessories

Clinotronic S

Zubehör



The wylerMASTER is designed exclusively to calibrate inclination devices of the typ Clinotronic S and Clinotronic PLUS with a measuring range of $\pm 45^\circ$.

Der wylerMASTER ist ausschliesslich für das Kalibrieren von Neigungsmessgeräten vom Typ Clinotronic S und Clinotronic PLUS mit einem Messbereich von $\pm 45^\circ$ bestimmt.

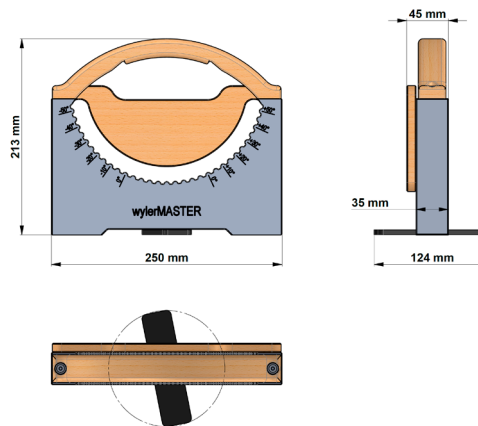

Specifications	wylerMASTER			Spezifikationen
Range of calibration	$\pm 50^\circ$			Kalibrierbereich
Steps of calibration	5°			Kalibrierung in Schritten
Geometric precision	0 ... 10° 5 arcsec	15 ... 25° 10 arcsec	30 ... 50° 15 arcsec	Geometrie-Genauigkeit
Operation temperature	18 ... 23 °C			Betriebstemperatur
Storage temperature	-30 ... 70 °C			Lagertemperatur
Weight net	6.2 kg			Gewicht netto
Weight scope of delivery	7.8 kg			Gewicht Lieferumfang
Dimensions L x W x H	250 x 45 x 213 mm			Abmessungen L x B x H
Dimensions L x W x H / support extended	250 x 124 x 213 mm			Abmessungen L x B x H / Stützen ausgefahren

Material

- Body: stainless steel, hardened 55 HRC
- Handle and back plate: steamed, varnished wood
- Support: POM

Material

- Körper: Stahl rostfrei, gehärtet 55 HRC
- Griff und Rückplatte: Schicht-Holz gedämpft, lackiert
- Stütze: POM

Scope of delivery	P/N Produktnummer	Lieferumfang
<ul style="list-style-type: none"> • wylerMASTER • Quick reference • SCS certificate • Case for storage, transport and shipping 390 x 310 x 147 mm 	200-015-0001	<ul style="list-style-type: none"> • wylerMASTER • Kurzanleitung • SCS-Zertifikat • Gerätekofter für Lagerung, Transport und Versand 390 x 310 x 147 mm

Calibration certificate	P/N	Produktnummer	Kalibrierzertifikat
SCS calibration certificate for wylerMASTER		SCS MASTER	SCS-Kalibrierzertifikat für wylerMASTER

Specifications

Clinotronic PLUS

Spezifikationen



Specifications	Clinotronic PLUS				Spezifikationen
Sensitivity	5 arcsec				Zifferschrittwert
Measuring range	±45°		±60°		Messbereich
Within the range of ...	0 ... 10°	10 ... 30°	30 ... 45°	45 ... 60°	Im Bereich von ...
Limits of error within 12 months* (T _A = 20°C) T _A = ambient temperature	≤ 1 arcmin + 1 digit	≤ 1.5 arcmin + 1 digit	≤ 2 arcmin + 1 digit	≤ 3 arcmin + 1 digit	Fehlergrenze innerhalb von 12 Monaten* (T _A = 20°C) T _A = Umgebungstemperatur
Response time	< 5 sec				Einstelldauer
Digital output	RS485, asynchronous, 7 DataBits, 2 StopBits, no parity, 9600 bps				Digitalausgang
Batterie, size AA Optional (rechargeable)	1 x 1.5 V Alkaline 1 x 1.2 V NiMH				Batterie, Grösse AA Optional (wiederaufladbar)
Operating temperature	0 ... 40 °C				Betriebstemperatur
Storage temperature	-30 ... 70 °C				Lagertemperatur
Net weight, including batteries Housing aluminum hard anodized	400 g				Netto-Gewicht, inklusive Batterien Aluminiumgehäuse harteloxiert
Length	100 mm				Länge
Width	30 mm				Breite
Height	75 mm				Höhe
CE conformity Meets emission and immunity requirements					CE-Konformität Erfüllt die Standards für Emission und Störfestigkeit

*typical value

*typischer Wert

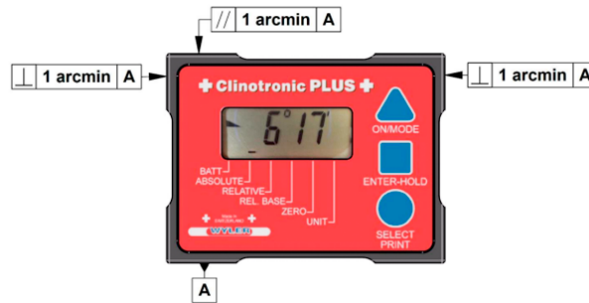

Units	Decimals Dezimalstellen	Value in Display Wert in der Anzeige	Unit in Display Einheit in der Anzeige	Einheiten
mm per m	2	xx.xx	mm/m	mm pro m
Inch per 10 inch	4	.xxxx	"/10"	Zoll pro 10 Zoll
Inch per 12 inch	4	.xxxx	"/12"	Zoll pro 12 Zoll
milli radian	2	xx.xx	mRad	Milli-Radian
milli radian	0	.xxxx	mRad	Milli-Radian
degree	2	xx.xx°	DEG	Grad
degree	4	.xxxx°	DEG	Grad
degree + arc minutes		xx'xx'	DEG	Grad + Bogenminuten
arc minutes + arc seconds		xx'xx"	DEG	Bogenminuten + Bogensekunden
centesimal degree	2	xx.xx	GON	Neugrad
centesimal degree	4	.xxxx	GON	Neugrad
mm per relative base	2	xx.xx	mm/m *)	mm pro relative Basis
mm per relative base	4	.xxxx	mm/m *)	mm pro relative Basis
Inch per relative base	4	.xxxx	"/10" *)	Zoll pro relative Basis
artillery per mill	0	xxxx		Artillerie Promille

*) Cursor at the position "REL.BASE"

*) Cursor bei der Position "REL.BASE"

Specifications

Clinotronic PLUS

Spezifikationen

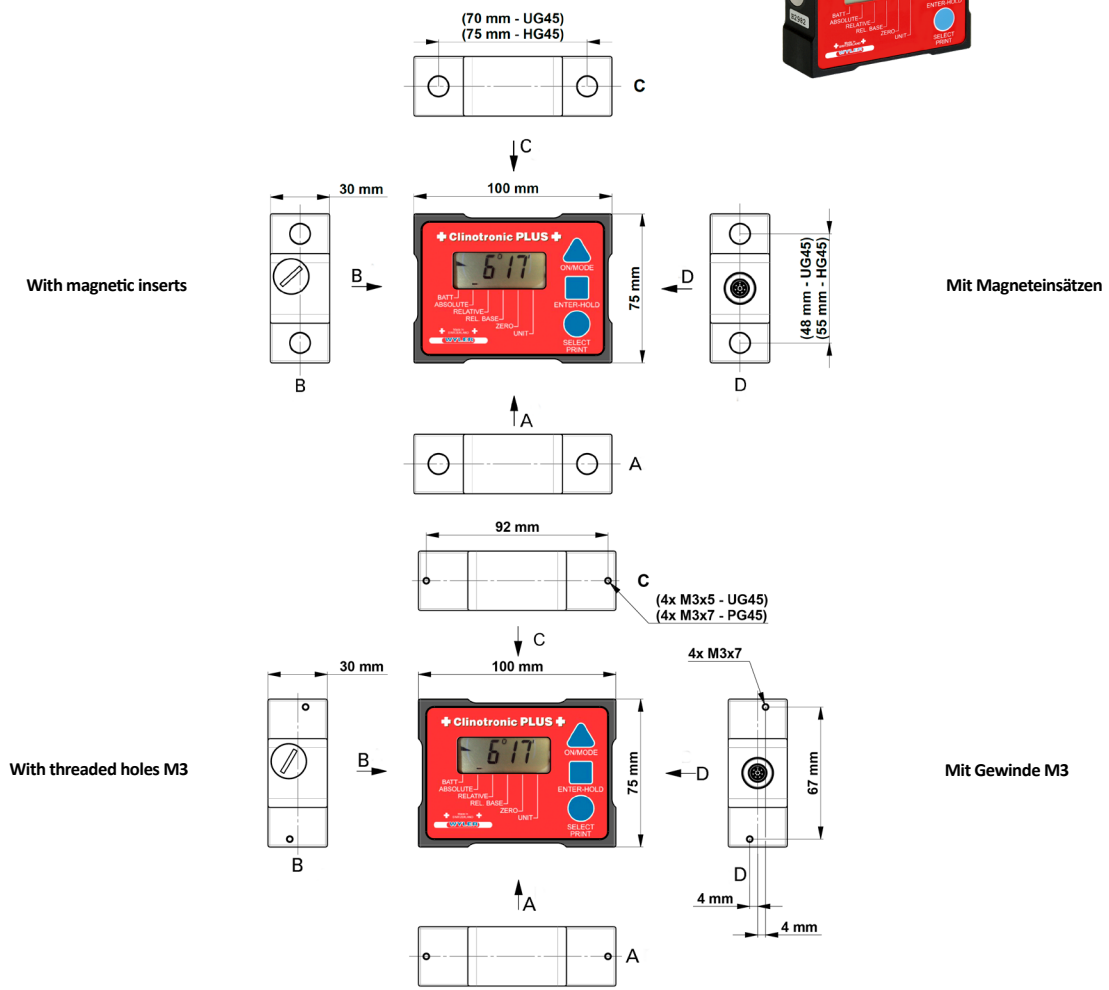

Types

Clinotronic PLUS

Typen

Clinotronic PLUS									
Magnetic inserts Magneteinsätze				P/N Produktnummer	P/N Produktnummer	Threads M3 Gewinde M3			
Bottom Unten	Left Links	Top Oben	Right Rechts	± 45°	± 60°	Bottom Unten	Left Links	Top Oben	Right Rechts
X	X	X	X	015-PLUS-XG45	015-PLUS-XG60				
				015-PLUS-HG45	015-PLUS-HG60				
X	X	X	X	015-PLUS-PG45	015-PLUS-PG60	X	X	X	X
X	X	X	X	015-PLUS-UG45	015-PLUS-UG60	X	X	X	X

Scope of delivery	Lieferumfang
<ul style="list-style-type: none"> 1 Clinotronic PLUS 1 Battery 1.5V, size AA 1 Manual 1 Storage case 	<ul style="list-style-type: none"> 1 Clinotronic PLUS 1 Batterie 1.5V, Grösse AA 1 Bedienungsanleitung 1 Gerätekoffer

Calibration certificate	P/N	Produktnummer	Kalibrierzertifikat
SCS calibration certificate for 1 Clinotronic PLUS		SCS CLINOTRONIC	SCS-Kalibrierzertifikat für 1 Clinotronic PLUS

Accessories

Clinotronic PLUS

Zubehör



Batteries	Details	P/N Produktnummer	Batterien
Battery, size AA (single)	1.5 V Alkaline	604-012-0001	Batterie, Grösse AA (einzeln)
Battery for Clinotronic (predecessor of Clinotronic PLUS)	3.6 V	604-015-0001	Batterie für Clinotronic (Vorgängermodell von Clinotronic PLUS)

Cable and adapters connecting Clinotronic PLUS to PC	P/N Produktnummer	Kabel und Adapter zur Verbindung von Clinotronic PLUS an PC
RS232 cable 2.5 m (only in combination with the software LabEXCEL CLINO)	015-025-928-232	RS232 Kabel 2.5 m (nur in Kombination mit der Software LabEXCEL CLINO)
USB cable 1.8 m (only in combination with the software LabEXCEL CLINO)	015-018-468-USB	USB Kabel 1.8 m (nur in Kombination mit der Software LabEXCEL CLINO)
Adapter RS232 / USB	024-232-USB	Adapter RS232 / USB

Various	P/N Produktnummer	Verschiedenes
Remote button (key) cable, 2.5 m	015-025-8D1PLUS	Auslösetaster mit Kabel, 2.5 m
wylerTRIGGER	015-005-007	wylerTRIGGER

Cast iron,
surface chromium-plated



Grauguss,
Flächen verchromt

Specifications	clinoMASTER	Spezifikationen
Range of calibration	±50°	Kalibrierbereich
21 steps of calibration	21 x 5°	21 Kalibrierschritte
Geometric precision	30 arcsec	Geometrie-Genauigkeit
Operation temperature	18 ... 23 °C	Betriebstemperatur
Storage temperature	-30 ... 70 °C	Lagertemperatur
Weight	8.4 kg	Gewicht
Length x Width x Height	250 x 62 x 150 mm	Länge x Breite x Höhe
Material		Material
Cast iron, surface chromium-plated		Grauguss, Flächen verchromt

Scope of delivery	P/N Produktnummer	Lieferumfang
<ul style="list-style-type: none"> clinoMASTER SCS certificate Case for storage and transport 	015-000-021	<ul style="list-style-type: none"> clinoMASTER SCS-Zertifikat Gerätekoffer für Lagerung und Transport

Calibration certificate	P/N	Produktnummer	Kalibrierzertifikat
SCS calibration certificate for clinoMASTER		 SCS MASTER	SCS-Kalibrierzertifikat für clinoMASTER

Innovation, quality, service, sustainability and social responsibility - since 1928.

WYLER AG is continuously enhancing their products and reserves the right to change technical specifications as well as the appearance without prior notice. For this reason the specifications and the pictures of the products delivered may differ from those shown in the catalog.



Innovation, Qualität, Service, Nachhaltigkeit und soziale Verantwortung - seit 1928.

Die WYLER AG entwickelt ihre Produkte laufend weiter und behält sich das Recht vor, technische Spezifikationen sowie das Aussehen ohne vorherige Ankündigung zu ändern. Aus diesem Grund können die technischen Daten und die Abbildungen der gelieferten Produkte von den im Katalog gezeigten abweichen.

WYLER AG

Inclination Measuring Systems

Neigungsmesssysteme

Im Hölderli 13, 8405 Winterthur, Switzerland

Tel. +41 52 233 66 66

www.wylerag.com | wyler@wylerag.com